

BUS

Wired electro-installation



www.elkoep.com/bus





ELKO EP

ELKO EP have been your partner in the field for 30 years, developing and manufacturing the highest quality electronic devices for electroinstallation as well as smart system for residential and building automation.

ELKO EP employs more than 330 people across 15 foreign branches and exports its products to more than seventy countries. Company of the Year, Visionary of the Year, Superbrands and Global Exporter of the Year are just some of the awards we have received throughout the years as we consistently strive to move forward in the field of innovation and development.

Millions of relays, thousands of smart homes, hundreds of buildings and many satisfied customers - This is ELKO EP; a traditional company based in the center of Europe, where own development, production, logistics, and service are at the forefront of our focus.

Facts and stats



30 %

Czech

40 %

export

30 %

branches



WORLDWIDE

11 branches
6 franchises
70 export countries

350

employees
in holding

30 000 +

iNELS
installations

30 000 000 +

manufactured
products

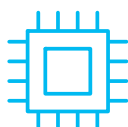

R&D

continuously
innovative

MANUFACTURER

fully automated
complete proces

SUPPORT

24 / 7 / 365

World leader
in DIN rail relays production

iNELS BUS infrastructure	6
iNELS topology	8
Overview of system units	10

Central units

CU3-07M Central unit with 1x BUS, 1x EBM	14
CU3-08M Central unit with 2x BUS	15
CU3-09M/DALI Central unit with 1x BUS, 1x DALI - NEW!	16
CU3-10M Central unit with 1x BUS, 1x MODBUS - NEW!	17

System units

PS3-30/iNELS Power supply with BUS separator	18
BPS3-01M, BPS3-02M Bus separator from power supply	19
PSM3-30/iNELS, PSM3-60/iNELS, PSM3-100/iNELS Power supplies for iNELS BUS	20

Lighting control

EMDC-64M Converter iNELS EBM - DALI/DMX	22
---	----

Detectors | sensors

MCD3-1 Ultra slim microwave motion detector - ceiling mount - NEW!	23
PMS3-1 Ultra slim PIR motion detector - ceiling mount - NEW!	24
DLS3-1 Light intensity sensor	25

Converters

ADC3-60M Analog-to-digital converter, 6 input	26
DAC3-04M Digital-to-analog converter, 4 input	27

Switching actuators

SA3-01B, SA3-02B Switching actuator, 1 channel and 2 channels	28
SA3-04M Switching actuator, 4 channels	29
SA3-06M Switching actuator, 6 channels	30
SA3-014M & SA3-014M/E Switching actuator, 14 channels - NEW!	31
SA3-022M Switching actuator, 22 channels	32
EA3-022M Switching actuator without controls and indicators, 22 channels	33

Shutter actuators

JA3-014M & JA3-014M/E Shutter actuator, 14 channels - NEW!	34
---	----

Dimming actuators

DA3-22M Universal dimming actuator, 2 channels	36
DA3-66M Dimming actuator, 6 channels	37
DA3-03M/RGBW Dimming actuator for RGBW strips	38

Input units

IM3-40B, IM3-80B Binary input units, 4 channels and 8 channels	39
IM3-140M Binary input unit, 14 channels	40
TI3-40B Temperature input, 4 channels	41
TI3-60M Temperature input, 6 channels	42

Combined units

RC3-610M/DALI Room controller with DALI dimmer - NEW!	43
FA3-612M Special unit for controlling fan coils	44
IOU3-108M Universal unit with inputs and outputs, 10 inputs and 8 outputs	45

Wall controllers

WSB3-20, WSB3-20H | Wall switch button, 2 buttons 46
 WSB3-40, WSB3-40H | Wall switch button, 4 buttons 47
 WMR3-21 | Wall card reader 48

Glass controllers

GMR3-61 | Glass card reader 49
 GSB3-40, GSB3-60, GSB3-90, GSB3-240, GSB3-260, GSB3-290 | Glass switch button - **NEW!** 50
 GSB3-40/S, GSB3-60/S, GSB3-90/S, GSB3-240/S, GSB3-260/S, GSB3-290/S | Glass switch button with symbols - **NEW!** 52

Metal controllers

MSB3-40, MSB3-60, MSB3-90 | Metal switch button - **NEW!** 54

Thermo-regulators

IDRT3-1 | Digital room thermo-regulator 56
 GRT3-50 | Glass room thermo-regulator 57
 GRT3-70, GRT3-270 | Glass room thermo-regulator - **NEW!** 58

Touch units

EST4 | 4" touch control panel - **NEW!** 59
 iNELS TOUCH iA10 | 10" touch control panel - **NEW!** 60

Integration

iNELS Bridge | Third-party integration gateway - **NEW!** 61
 Connection Server II. | Third-party integration server - **NEW!** 62
 MQTT | The Standard for IoT Messaging 64

Multimedia

LARA Radio 66
 LARA Intercom 67
 LARA accessories 68

iNELS app

..... 70

Accessories iNELS

TELVA-2 230V, TELVA-2 24V | Thermodrive 72
 TC, TZ, Pt100 | Thermo sensors 73

 BUS electro-installation 74
 Product loadability 75
 Loadability of contacts 76
 Installation possibilities 78
 Dimensions 80

Open topology with new possibilities

iNELS BUS comes with a progressive system architecture using the IP protocol and MQTT protocol.

Evolutionary change in the structure of the connection to the units in the iNELS units and iNELS BUS, it is now possible to use the IP protocol and MQTT protocol to connect individual unit's in the central units and to the units connected to other central units in same network . The new IP infrastructure brings about the full potential of using iNELS bus units in small, medium and very large installations.

MiniCU Family

Unlike the previous version of iNELS BUS, where all buses were connected to one central unit, in the new structure each bus is fully autonomous, thanks to the minified version of the central unit (CU3-07 / 08M / 09M / 10M). MiniCU (short name for single-module central unit) is a full-fledged central unit that controls only 1 or 2 buses with additional bus EBM/Dali/Modbus. The main difference is that full functionality is maintained even if communication with other units is lost, so that all units connected to the MiniCU remain interconnected, including all predefined links. After the connection with the superior units is re-established, the centrally controlled functions will only be synchronized and restored.

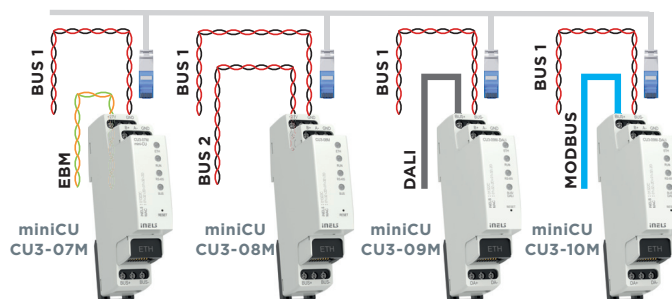

	CU3-07M	CU3-08M	CU3-09M	CU3-10M
BUS1	✓	✓	✓	✓
BUS2		✓		
EBM BUS	✓			
DALI BUS			✓	
MODBUS				✓

Central control even for large installations

Central control of automation devices in large installations is an effective way to streamline operations, enhance safety, and reduce costs. It refers to the process of managing and coordinating the operation of numerous iNELS devices from a central location. The central control system serves as a hub that connects and monitors various iNELS devices, including sensors, actuators, and controllers. The iNELS system uses a network of communication protocols such as MQTT and IP protocol to collect and exchange data from the connected devices, enabling the devices to work in harmony.

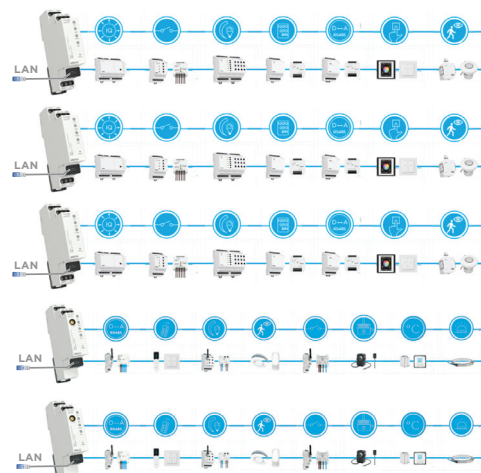

MQTT in Central units for easy integration and control

To keep the integration simple, we have implemented MQTT communication in all our central units. Since it is industry protocol with a fast response time, It makes the interaction between devices efficient, whatever the number of devices there is. We used MQTT as a light and energy-efficient communication protocol in our BUS and wireless solution. This allows to use data and logics from iNELS units to sends it to the other system with real-time.

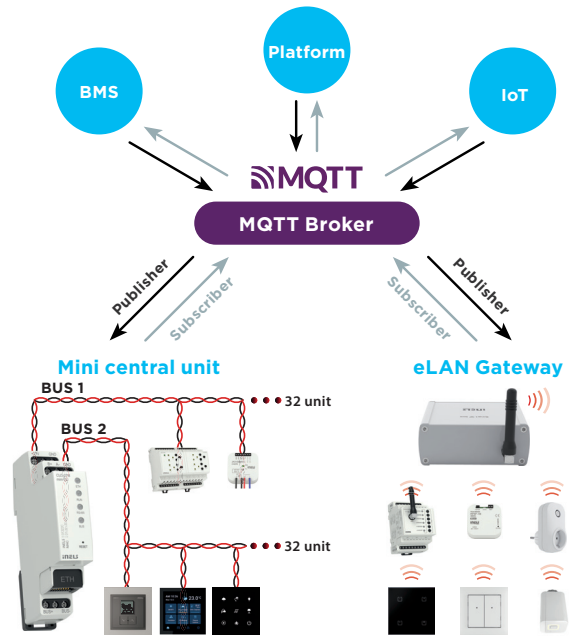

Central supervision & global conditionality

The new IP infrastructure consists not only in the connection between the MiniCU, but also in the connection to the central iNELS CLOUD system. Using the cloud, it is possible to connect, individual Central units with all their subordinate units, buses and elements. This creates not only the possibility of unlimited scaling of the iNELS BUS system, but also the possibility of creating interrelated functions, where the control element on one installation can control the actuators on a geographically remote installation controlled by another Central unit or eLAN gateway.

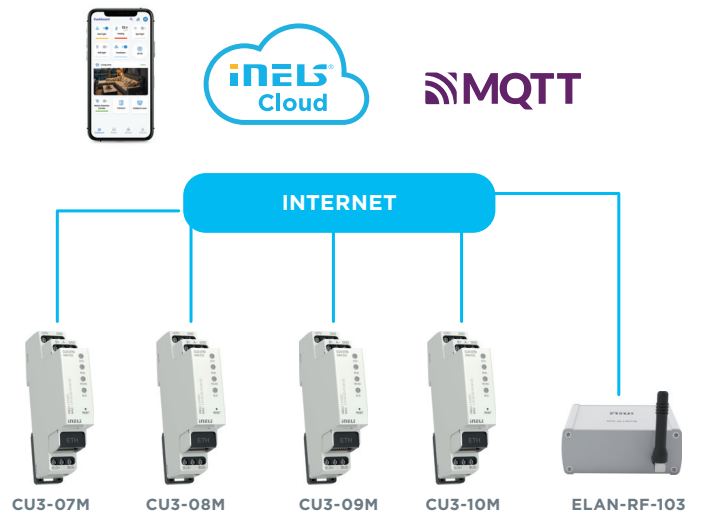

iNELS Bridge

The new IP infrastructure also includes the option of connecting iNELS central units (wired/wireless technology) and newly implemented third-party integration control unit iNELS Bridge. With the help of iNELS Bridge, It is possible to integrate almost the entire iNELS portfolio, including third-party devices that can be connected using the open Home Assistant platform. iNELS Bridge is also pre installed with Connection server and Asterisk for 3rd party integration.

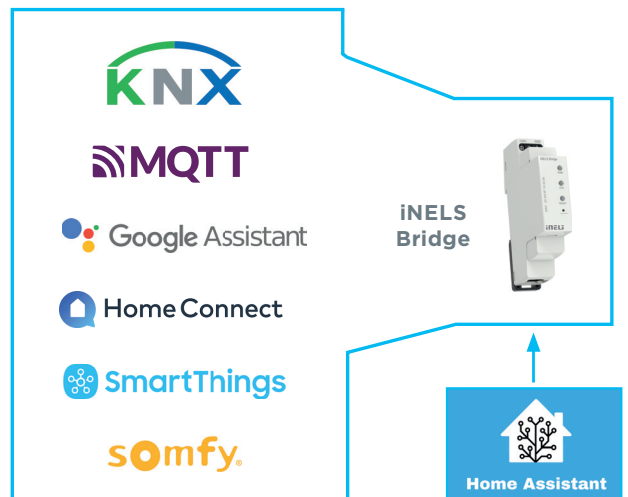

Protocols

ASIRAC BACnet™ M-Bus
 Modbus Java
 HTTP API { json }

Integrations

Home Assistant
 Asterisk
 Node-RED
 MQTT Broker

iNELS Bridge



MQTT

Building management system

EasyIO® iRidi
 NETX AUTOMATION niagara framework®
 Opera FLOWBOX

Heating & Cooling

DAIKIN Panasonic LG
 IntesisBox® GREE
 COOLAUTOMATION SAMSUNG
 INSPINIA
 Aircon Interfaces

3rd party systems

KNX PHILIPS hue tuya
 ZWAVE CRESTRON Control4
 LUTRON somfy.

Cameras & Intercoms

dahua HIKVISION 2N
 An Axis company

Access control systems & PMS

VingCard Elsafe HID® Opera
 Onity SALTO inspiredaccess
 dormakaba

Visualization

INSPINIA
 Inspinia SQ 8" panel Inspinia SQ 10" panel
 Inspinia RT 4" Retrofit panel Inspinia SQ 4" Room Controller

LOCAL NETWORK

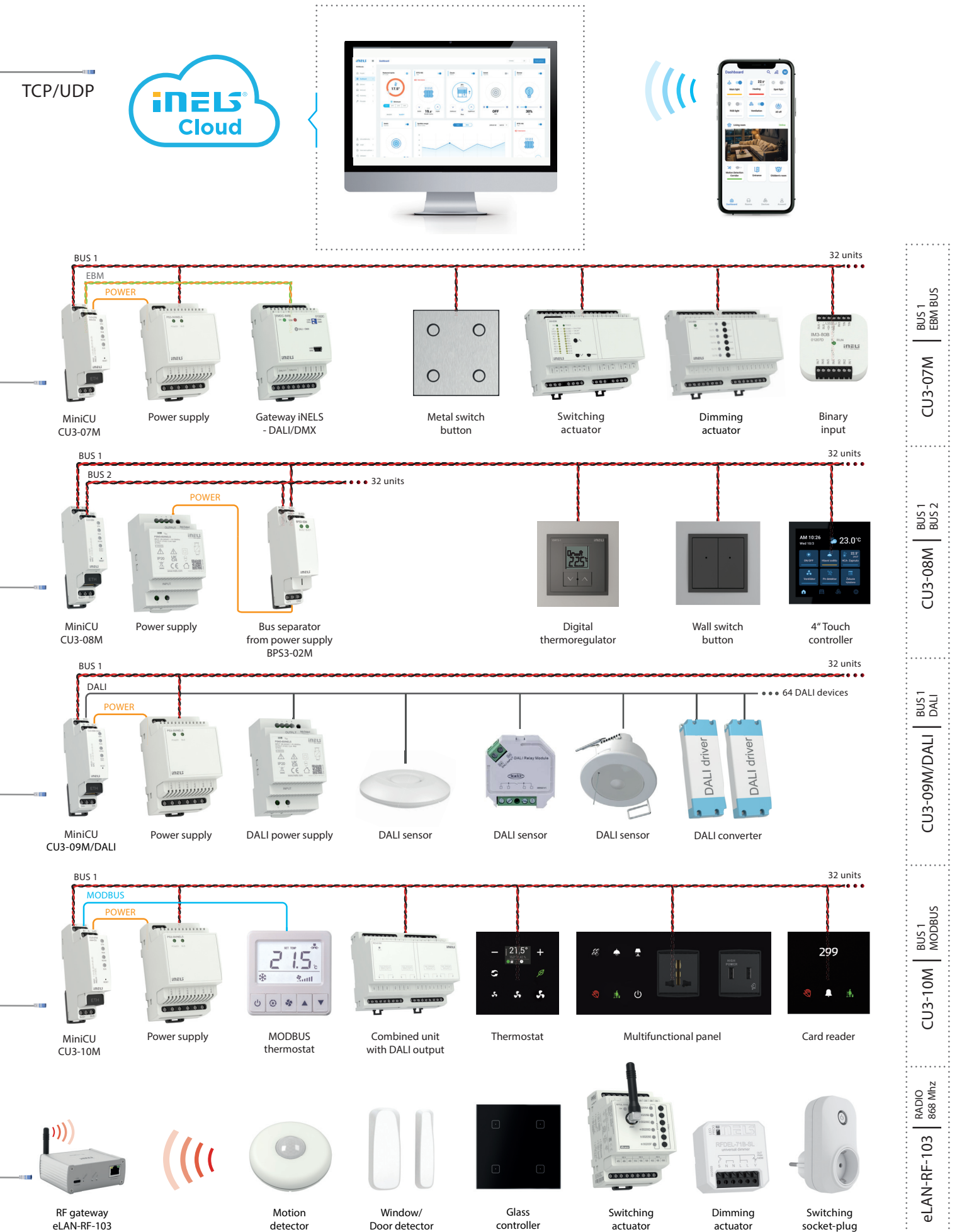

Central units

System units



CU3-07M
Central unit
with 1x BUS, 1x EBM,
max. 32 Elements



CU3-08M
Central unit
with 2x BUS,
max. 64 Elements



CU3-09M/DALI
Central unit
with 1 BUS, 1x DALI,
max. 32 Elements



CU3-10M
Central unit
with 1x BUS,
1x MODBUS



PS3-30/iNELS
Power supply
with integrated BUS
separator



BPS3-01M, BPS3-02M
Bus separator
from power supply



PSM3-30/iNELS
Power supply
for iNELS BUS



PSM3-60/iNELS
Power supply
for iNELS BUS



PSM3-100/iNELS
Power supply
for iNELS BUS



EMDC-64M
Converter iNELS
EBM - DALI/DMX
max. 64 address

Detectors | sensors

Converters



MCD3-01
Ultra slim microwave motion
detector - ceiling mount



PMS3-01
Ultra slim PIR motion
detector - ceiling mount



DLS3-1
Light intensity
sensor



ADC3-60M
Analog-to-digital converter,
6 inputs



DAC3-04M
Digital-to-analog converter,
4 outputs

Switching actuators



SA3-01B, SA3-02B
Switching actuator,
1 channel and 2 channels



SA3-04M
Switching actuator,
4 channels



SA3-06M
Switching actuator,
6 channels



SA3-014M & SA3-014M/E
Switching actuator,
14 channels



SA3-022M
Switching actuator,
22 channels

Shutter actuators



EA3-022M
Switching actuator without controls and indicators, 22 channels



JA3-014M & JA3-014M/E
Shutter actuator, 14 channels

Dimming actuators



DA3-22M
Universal dimming actuator, 2 channels

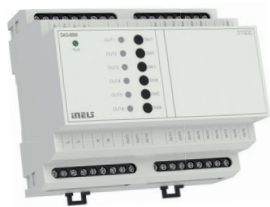

DA3-66M
Dimming actuator, 6 channels



DA3-03M/RGBW
Dimming actuator for RGBW strips



LBC3-02M
Dimming actuator for power supply 0-10V, 2 channels

Input units



IM3-40B
Binary input unit, 4 channels



IM3-80B
Binary input unit, 8 channels



IM3-140M
Binary input unit, 14 channels



TI3-40B
Temperature input, 4 channels

Combined units



RC3-610M/DALI
Room controller with DALI dimmer



FA3-612M
Special unit for controlling fan coils

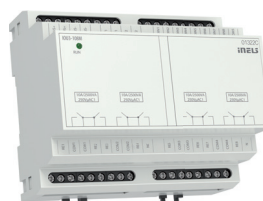

IOU3-108M
Universal unit with inputs and outputs, 10 inputs, 8 outputs

Wall controllers

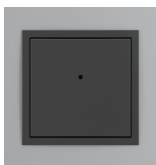

**WSB3-20,
WSB3-20H**
Wall switch button,
2 buttons

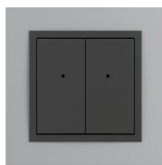

**WSB3-40,
WSB3-40H**
Wall switch button,
4 buttons

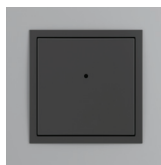

WMR3-21
Wall card reader

Glass controllers

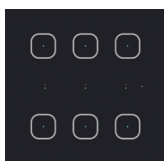

GMR3-61
Glass card reader



GSB3-40
Glass switch
button

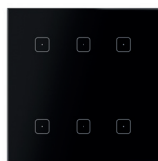

GSB3-60
Glass switch
button



GSB3-90
Glass switch
button

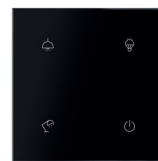

GSB3-40/S
Glass switch button
with symbols

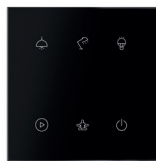

GSB3-60/S
Glass switch button
with symbols



GSB3-90/S
Glass switch button
with symbols

Metal controllers

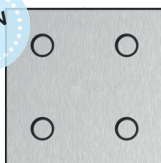

MSB3-40
Metal switch button

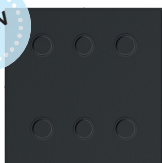

MSB3-60
Metal switch button

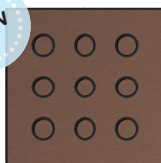

MSB3-90
Metal switch button

Thermo-regulators



IDRT3-1
Digital room
thermo-regulator

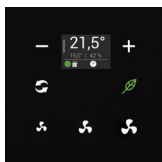

GRT3-50
Glass room
thermo-regulator



GRT3-70
Glass room
thermo-regulator



GRT3-270
Glass room
thermo-regulator

Touch units



EST4
4" touch control panel



iNELS TOUCH iA10
10" touch control panel

Integration



iNELS Bridge
Third-party integration gateway



Connection Server II.
Third-party integration server

Multimedia

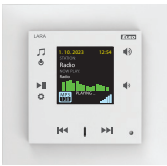

LARA Radio
Player Internet radio

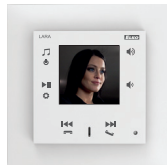

LARA Intercom
Multifunction communication equipment

iNELS app

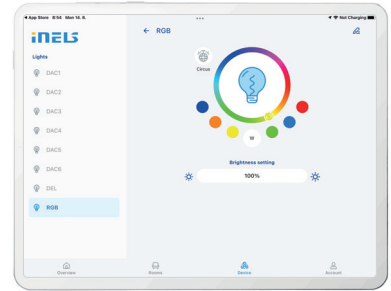
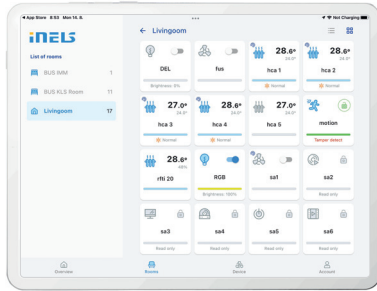
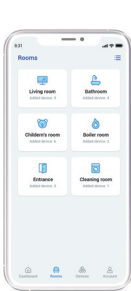
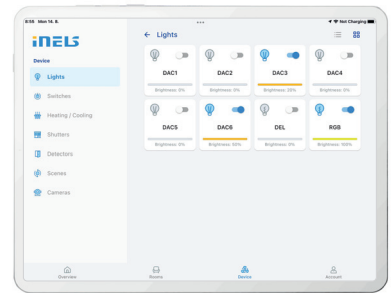
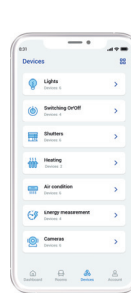
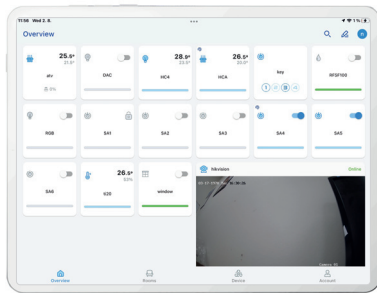

New application for controlling all compatible elements from the iNELS portfolio.

Accessories



**TELVA-2 230V,
TELVA-2 24V**
Thermdrive



AN-I, AN-E
Internal antenna
External antenna



TC, TZ, Pt100
Thermo sensors



EAN code
CU3-07M: 8595188180108

Technical parameters

CU3-07M

Indication LED STATUS

Green LED RUN:	Flashing-communication with BUS, On-no communication
Red LED ERR:	Flashing - no project, ON - unit STOP

Communication

iNELS BUS	
Indication (LED BUS):	green - unit status indication red - BUS fault indication
Maximum number of units:	max. 32 units to one BUS line
Maximum cable length:	max. 300 m (depends on power loss)

BUS EBM	
Indication:	green - indication communication red - faul indication
Maximum cable length:	max. 300 m

Ethernet	
Connector:	RJ45
Communication speed:	100 Mbps
Indication of the Ethernet (LED ETH):	green - Ethernet communication yellow - Ethernet speed 100 Mbps
The default IP address:	192.168.1.1

Button RESET	
Restart:	short press
Reset (Factory Reset):	press the button to apply power, release the button 10 s after power is applied

Power supply	
Supply voltage/tolerance:	27 V DC, -20/+10 %
Rated current:	50 mA (at 27 V DC)

Operating conditions	
Operating temperature:	-20 to +55 °C
Storage temperature:	-25 to +70 °C
Humidity:	max. 80%
Protection degree:	IP20 device, IP40 with cover in the switchboard
Overvoltage category:	II.
Pollution degree:	2
Operating position:	any
Installation:	to the switching board on the EN 60715 DIN rail
Design:	1-MODULE
Terminal:	max. 2.5 mm ²

Dimensions and weight	
Dimensions:	94 x 17.6 x 64 mm
Weight:	72 g

- CU3-07M is one of the basic system control units of iNELS BUS installations.
- The unit can work independently, as an autonomous project, or it can be controlled by the central software as part of a larger project.
- The units is equipped with one BUS to which it is possible to connect up to 32 elements from the iNELS BUS portfolio.
- The current load of one line is max, 1 A, BPS3-01M with 3 A can be used incase of connected device with more than 1 A.
- The CU3-07M unit is equipped with one EBM bus. The EBM system bus allows to connect central unit with converter DALI/DMX EMDC-64M.
- The RJ45 100 Mbps Ethernet connector is used for direct communication with the cloud for mobile app control or for communication with the superior unit within the iNELS IP topology.
- Configuration takes place in the iNELS3 Designer & Manager software (iDM3).
- Through iDM3 it is possible to update the firmware of central units and bus connected peripheral units.
- The central unit is implemented with MQTT protocol for 3rd party communication.
- The units is powered by 27 V DC from iNELS power supply.
- System units CU3-07M in 1-MODULE design are designed for mouting into a switchboard on DIN rail EN60715.

Connection

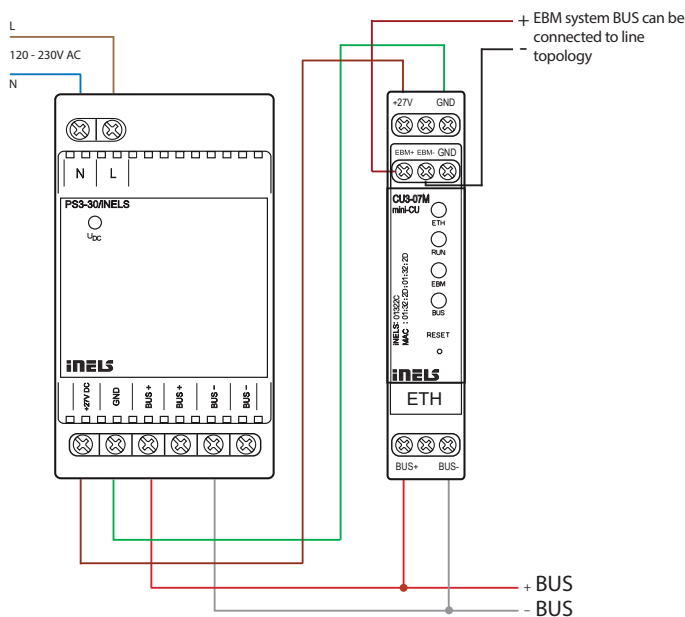

max. 32 units per BUS; max. 1A (PSS-30 / iNELS) per BUS



EAN code
CU3-08M: 8595188184403

Technical parameters		CU3-08M
Indication LED STATUS		
Green - RUN:	The main program runs	
Red- ERR:	The main program stalled	
Communication		
System bus BUS1/BUS2		
Status indication (LED BUS):	green - indication of the operating status of the bus red - error indication on the bus	
Maximum number of units:	2x32 Units	
Maximum line length:	max. 300 m (depends on power loss)	
Ethernet		
Connector:	RJ45	
Communication speed:	100 Mbps	
Ethernet status indication (LED ETH):	green - Ethernet communication yellow - Ethernet speed 100 Mbps	
Default IP address:	192.168.1.1	
RESET button		
Restart:	Short press	
Reset (factory reset settings):	press the button to bring power on, button release 10 s after power is supplied	
Power		
BUS1		
Supply voltage/tolerance:	27 V DC, -20/+10 %	
Rated current:	50 mA (at 27 V DC)	
BUS2		
Supply voltage/tolerance:	27 V DC, -20/+10 %	
Rated current:	50 mA (at 27 V DC)	
Operating conditions		
Working temperature:	-20 to +55 °C	
Storage temperature:	-25 to +70 °C	
Air humidity:	max. 80%	
Degree of protection:	IP20 device, IP40 with cover in the control cabinet	
Surge category:	II.	
Degree of pollution:	2	
Working position:	any	
Installation:	to the control cabinet for DIN rail EN 60715	
Design:	1-MODULE	
Terminal plate:	max. 2.5 mm ²	
Dimensions and weight		
Dimensions:	94 x 17.6 x 64 mm	
Weight:	72 g	

- CU3-08M is one of the basic system control of iNELS BUS installations.
- The unit can work independently, as an autonomous project, or it can be controlled by the central software as part of a larger Project.
- The units is equipped with two BUS, to which it is possible to connect a total of up to 64 elements (2x32) from the iNELS BUS portfolio.
- The current load of one line is max. 1 A. BPS3-01M with 3 A can be used in case of connected device with more than 1 A.
- The RJ45 100 Mbps Ethernet connector is used for direct communication with the cloud for mobile app control or for communication with the superior unit within the iNELS IP topology.
- Configuration takes place in the iNELS3 Designer & Manager software (iDM3). Through iDM3 it is possible to update the firmware of central units and bus connected peripheral units.
- The central unit is implemented with MQTT protocol for 3rd party communication.
- The units is powered by 27 V DC from iNELS power supply. BUS1 can power the central unit.
- System units CU3-08M in 1-MODULE design are designed for mounting into a switchboard on DIN rail EN60715.

Connection

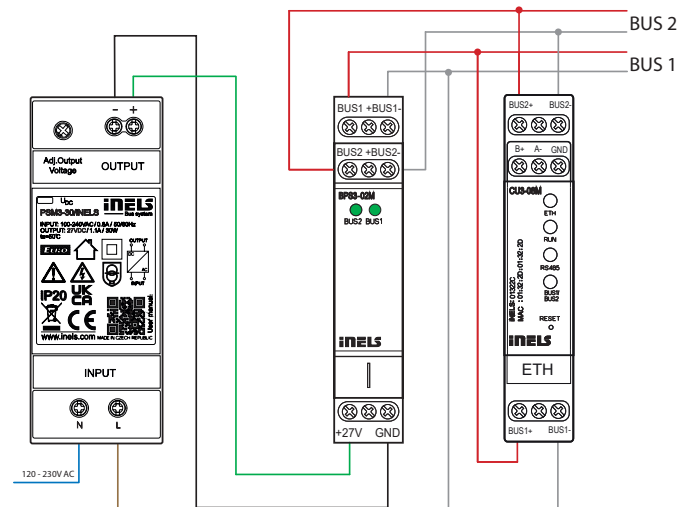



EAN code
CU3-09M/DALI: 8595188184656

Technical parameters

CU3-09M/DALI

Indication LED STATUS

Green - RUN:	The main program runs
Red - ERR:	The main program stalled

Communication

System BUS

Maximum number of units:	max. 32 Units
Status indication (LED BUS):	green: BUS Operating Status red: error indication on the bus
Bus power supply:	external DALI power supply must be connected

Ethernet

Connector:	RJ45
Communication speed:	100 Mbps
Ethernet status indication (LED ETH):	green - Ethernet communication yellow - speed Ethernet 100 Mbps
Default IP address:	192.168.1.1

RESET button

Restart:	short press
Reset (return to factory settings):	press the button to bring power on, button release 10 s after power is supplied

Power

Supply voltage/tolerance:	27 V DC, -20/+10 %
Rated current:	50 mA (at 27 V DC)

Operating conditions

Working temperature:	-20 to +55 °C
Storage temperature:	-25 to +70 °C
Air humidity:	max. 80%
Degree of protection:	IP20 device, IP40 with cover in the control cabinet
Surge Category:	II.
Degree of pollution:	2
Working position:	any
Installation:	to the control cabinet for DIN rail EN 60715
Design:	1-MODULE
Terminal plate:	max. 2.5 mm ²

Dimensions and weight

Dimensions:	94 x 17.6 x 64 mm
Weight:	72 g

- CU3-09M is one of the basic system control units of iNELS BUS installations.
- The unit can work independently, as an autonomous project, or it can be controlled by the central software as part of a larger project.
- The unit is equipped with one BUS to switch it is possible to connect up to 32 elements from the iNELS BUS portfolio.
- The current load of one line is max. 1 A. BPS3-01M with 3 A can be used in case of connected device with more than 1 A.
- The CU3-09M/DALI system unit is equipped with one DALI bus.
- The DALI system bus allow control of up to 64 independent DALI ballast addresses for luminaires.
- Addressing of DALI can be done via the iDM3 software.
- The RJ45 100 Mbps Ethernet connector is used for direct communication with the cloud for mobile app control or for communication with the superior unit within the iNELS IP topology.
- Configuration takes place in the iNELS3 Designer & Manager software (iDM3).
- Through iDM3 it is possible to update the firmware of central units and bus connected peripheral units.
- The central unit is implemented with MQTT protocol for 3rd party communication.
- The unit is powered by 27 V DC from iNELS power supply. BUS1 can power the central unit.
- System units CU3-09M/DALI in 1-MODULE design are designed for mounting into a switchboard on DIN rail EN60715.

Connection

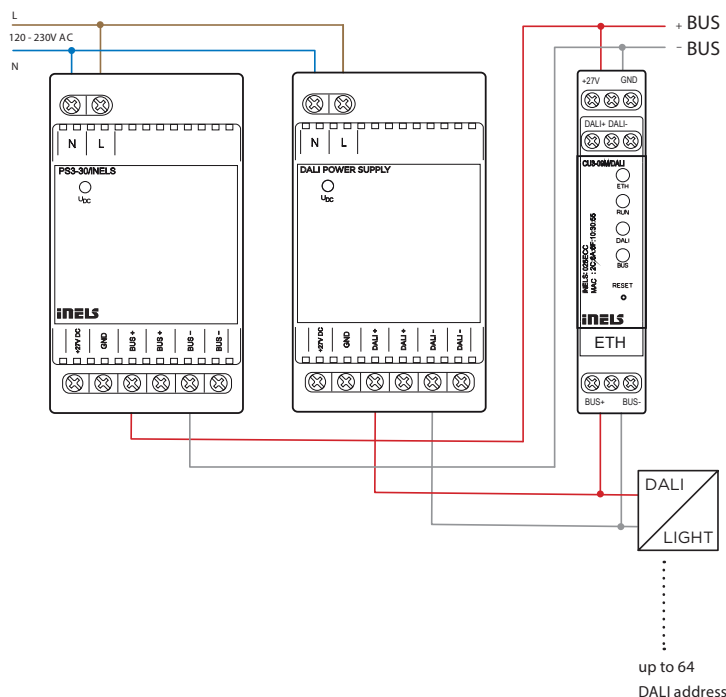

up to 64
DALI address



EAN code
CU3-10M: 8595188185219

Technical parameters **CU3-10M**

Indication LED STATUS

Green - RUN:	Flashing-communication with BUS, On-no communication
Red- ERR:	Flashing - no project, ON - unit STOP

Communication

System bus BUS1	
Status indication (LED BUS):	green - unit status indication red - BUS fault indication
Maximum number of units:	max. 32 units to one BUS line
Maximum line length:	max. 300 m (depends on power loss)

Ethernet

Connector:	RJ45
Communication speed:	100 Mbps
Ethernet status indication (LED ETH):	green - Ethernet communication yellow - Ethernet speed 100 Mbps
Default IP address:	192.168.1.1

RESET button

Restart:	short press
Reset (factory reset settings):	press the button to apply power, release the button 10 s after power is applied

Power

BUS	
Supply voltage/tolerance:	27 V DC, -20/+10 %
Rated current:	50 mA (at 27 V DC)

Operating conditions

Working temperature:	-20 to +55 °C
Storage temperature:	-25 to +70 °C
Air humidity:	max. 80%
Degree of protection:	IP20 device, IP40 with cover in the switchboard
Surge category:	II.
Degree of pollution:	2
Working position:	any
Installation:	to the switching board on the EN 60715 DIN rail
Design:	1-MODULE
Terminal plate:	max. 2.5 mm ²

Dimensions and weight

Dimensions:	94 x 17.6 x 64 mm
Weight:	72 g

- CU3-10M is one of the basic system control units of iNELS BUS installations.
- The unit can work independently, as an autonomous project, or it can be controlled by the central software as part of a larger project.
- The unit is equipped with one BUS to switch it is possible to connect up to 32 elements from the iNELS BUS portfolio.
- The current load of one line is max. 1 A. BPS3-01M with 3 A can be used in case of connected device with more than 1 A.
- The CU3-10M system unit is equipped with one Modbus system bus. The Modbus system bus allows control of modbus thermostat and Air condition units (RS-485).
- The RJ45 100 Mbps Ethernet connector is used direct communication with the cloud for mobile app control or for communication with the superior unit within the iNELS IP topology.
- Configuration takes place in the iNELS3 Designer & Manager software (iDM3). Through iDM3 it is possible to update the firmware of central units and bus connected peripheral units.
- The central unit is implemented with MQTT protocol for 3rd party communication.
- The unit is powered by 27 V DC from iNELS power supply.
- System units CU3-10M in 1-MODULE design are designed for mounting into a switchboard on DIN rail EN60715.

Connection

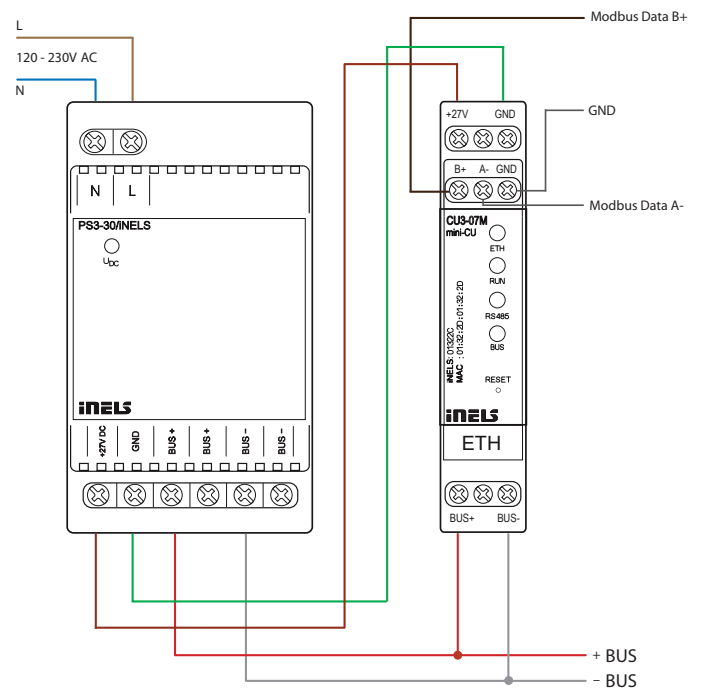



EAN code
PS3-30/iNELS: 8595188180115

Technical parameters

PS3-30/iNELS

Input AC

Supply voltage:	100 - 250 V AC/50 - 60 Hz
Power dissipation:	max. 6.5 W
No-load power (apparent/active):	max. 10 VA/1.5 W
Power consumption at max. Load (apparent/active):	max. 54 VA/33 W
Protection:	T2A fuse inside the device

Outputs

Output voltage:	27 V
Max. load capacity:	1 A
Overall resource efficiency:	> 82 %
Time delay after Connection to AC network:	max. 5 s

Indication LED

Green LED POWER:	Supply voltage indication
Green LED BUS:	indication of the operating status of the bus

Operating conditions

Electrical power INPUT AC - OUTPUT BUS:	4 kV
Connection terminals:	Ordinal
Cross-section of connecting wires (mm ²):	max. 1 x 2.5, max. 2 x 1.5 (With core max. 1 x 1.5)
Working temperature:	-20 °C to +55 °C
Storage temperature:	-30 °C to +70 °C
Working air humidity:	20 to 90 % RH
Degree of protection:	IP20 device, IP40 with cover in the control cabinet
Surge category:	III.
Degree of pollution:	2
Working position:	any, optimally vertical
Installation:	to the control cabinet for DIN rail EN 60715
Design:	3-MODULE
Dimensions:	90 x 52 x 65 mm
Weight:	160 g
Related standards:	general: EN61204, safety: EN61204-7, EMC: EN61204-3

- PS3-30/iNELS is a switched stabilized power supply with a total power of 30 W.
- PS3-30/iNELS is used to power central units and external masters within the iNELS bus wiring.
- PS3-30/iNELS it is equipped with electronic protection against short circuit, overvoltage, power and temperature overload.
- The power supply includes an internally integrated BPS3-01M bus isolator to power one branch of the BUS, from which the iNELS peripheral units are further powered.
- PS3-30/iNELS 3-MODULE is designed for mounting in a switchboard on DIN rail EN60715.

Connection

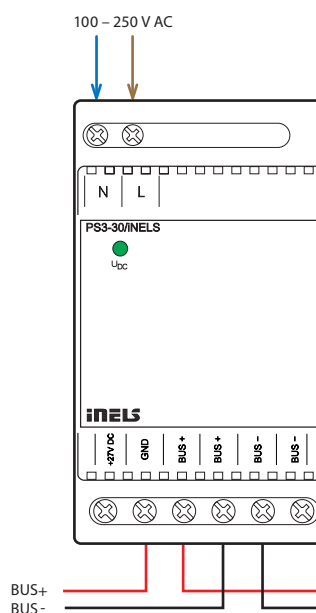



EAN code
 BPS3-01M: 8595188132442
 BPS3-02M: 8595188132435

Technical parameters	BPS3-01M	BPS3-02M
Outputs		
Maximum load capacity:	3 A	2x 1 A
Communication		
Installation bus:	1x BUS	2x BUS
Power		
Supply voltage/tolerance:	27 V DC, -20/+10 %	
Power dissipation:	max. 0.5 W	
Rated current without		
Output load:	max. 8 mA	max. 15 mA
Voltage status indication on		
Terminals:	1x green LED	2x green LED
Connection		
Terminal plate:	max. 2.5 mm ² /1.5 mm ² with core	
Operating conditions		
Working temperature:	-20 to +55 °C	
Storage temperature:	-30 to +70 °C	
Cover:	IP20 device, IP40 with cover in the control cabinet	
Surge category:	II.	
Degree of pollution:	2	
Working position:	any	
Installation:	to the control cabinet for DIN rail EN 60715	
Design:	1-MODULE	
Dimensions and weight		
Dimensions:	90 x 17.6 x 64 mm	
Weight:	70 g	85 g

- The BPS3-01M and BPS3-02M units are used for impedance separation of the BUS from the supply voltage source.
- A BPS3-01M or BPS3-02M bus isolator is required for each CU3-XXM central unit.
- BPS3-01M allows the connection of one BUS branch with a load of max. 3 A.
- BPS3-02M allows the connection of two BUS branches with a load of max. 1 A for each branch.
- The outputs are equipped with overcurrent and surge protection.
- Indication of the output voltage of the BUS outputs by LEDs.
- BPS3-01M, BPS3-02M in 1-MODULE design are designed for mounting in a switchboard on DIN rail EN60715.

Connection

BPS3-01M + CU3-07M

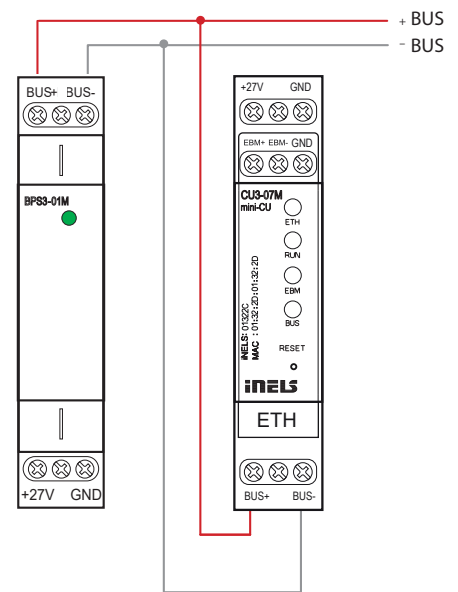

BPS3-02M + CU3-08M

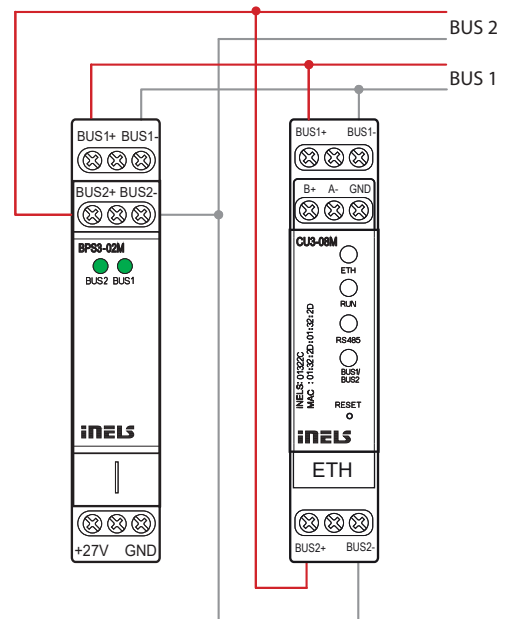

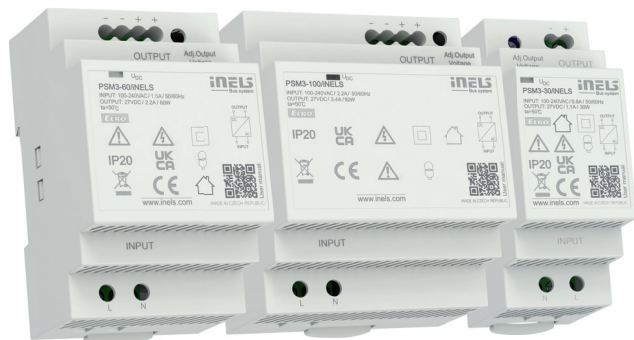

EAN code:
 PSM3-100/iNELS - 8595188184786
 PSM3-60/iNELS - 8595188184779
 PSM3-30/iNELS - 8595188184762

- Used to supply central units and external master within intelligent electroinstallation iNELS.
- Through BUS separators from the supply voltage BPS3-01M and BPS3-02M, it supplies BUS lines from which iNELS peripheral units are also powered.
- Rated output voltage 27V DC with the possibility of regulation.
- High efficiency of up to 90%.
- Low ripple & noise.
- Protection: Overload, Over voltage and Short circuit.
- Continuously adjustable output voltage to adapt to the specific application, e.g. the need to compensate for the voltage drop caused by the length of the line.

Technical parameters	PSM3-30/iNELS	PSM3-60/iNELS	PSM3-100/iNELS
Input			
Voltage range:	AC 100 - 240 V (50-60 Hz)		
Tolerance:	± 10%		
Efficiency:	89%	90%	90%
Burden without load (max.):	0.4W / 8VA	0.5W / 6.5VA	0.1W / 12VA
Burden with full load (max.):	33W / 60VA	70W / 111VA	105W / 160VA
Inrush current:*	max. 25A at 115V AC/60Hz max. 45A at 240V AC/50Hz	max. 30A at 115V AC/60Hz max. 60A at 240V AC/50Hz	max. 35A at 115V AC/60Hz max. 70A at 240V AC/50Hz
Output			
Rated voltage:	27V DC	27V DC	27V DC
Vol. setting range:	21.5 - 28.5V	20.5 - 29V	24.5 - 28V
Rated current:	1.1A	2.2A	3.4A
Rated power:	30W	60W	92W
Ripple & Noise:	150mV	150mV	150mV
Output indication:	blue LED	green LED	blue LED
Tolerance of output voltage:	5 %		
Overload protection:	from 130% - 200% rated output power		
Overvoltage protection:	from 110 % - 145% rated output power		
Overcurrent protection:	from 110% - 180% rated output power		
Short circuit protection:	temporarily disconnecting the output		
Other information			
Operating temperature:	-20 to +50°C		
Operating humidity:	20% ~ 90% non-condensing		
Storage temperature:	-40 to +80°C		
Dielectric strength:	3kV AC		
Isolation resistance:	100M Ω / 500V DC / 25°C / 70% RH		
Overvoltage category:	III.		
Pollution degree:	2		
Max. cable size:	max. 1x 2.5 mm ² , max. 2x 1.5 mm ² solid wire / with sleeve max. 1x 2,5 mm ²		
Terminal torque:			
Input terminals:	0.3 Nm		
Output terminals:	0.5 Nm		
Protection degree:	IP20		
MTBF:	200 000 hours minimum, full load at 25°C ambient temperature		
Mounting:	DIN rail EN 60715		
Dimensions:	90 x 35 x 58 mm	90 x 52.5 x 58 mm	90 x 70 x 58 mm
Weight:	120 g	190 g	270 g
Standards:	IEC60950-1, UL508, TUV EN61558-2-16		

* The stated values are valid for the full load from the source

Description

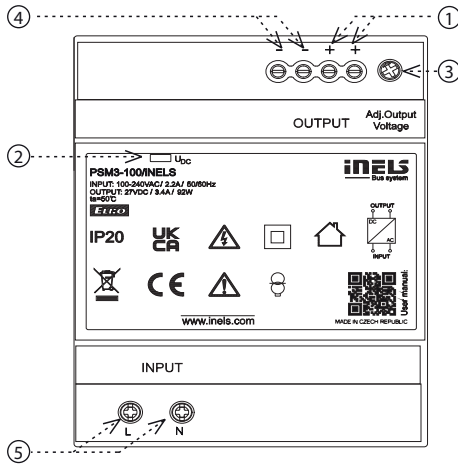
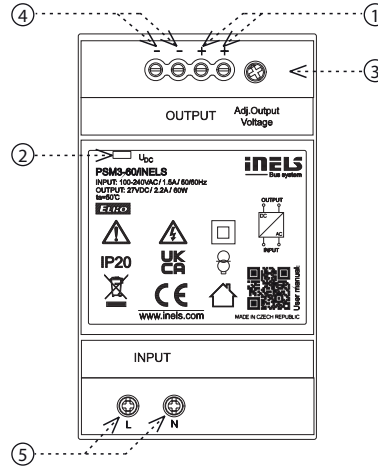
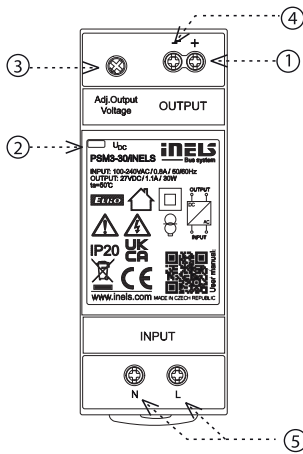

1. Output voltage terminals ⊕
2. Output voltage indication
3. Adjusting the output voltage
4. Output voltage terminals ⊖
5. Supply terminals

Connection

PSM3-30/iNELS

DC 27 V / 1.1 A

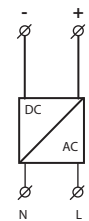

AC 100 - 240 V
50 Hz / 60 Hz

PSM3-60/iNELS

DC 27 V / 2.2 A

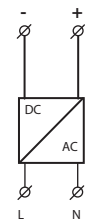

AC 100 - 240 V
50 Hz / 60 Hz

PSM3-100/iNELS

DC 27 V / 3.4 A

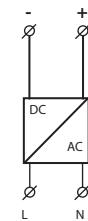

AC 100 - 240 V
50 Hz / 60 Hz

Power supplies PSxM are overcurrent protection devices, because it turns power supplies off, if the output current exceeds more than 30 % of the rated output of the power supply. Therefore, these units are not intended to supply e.g. halogen lamps, because the starting / inrush current (in the cold state) is approximately ten times the amount of the steady-state operating current. So these power supplies cannot turn on such lamps.



EAN code
EMDC-64M: 8595188150309

Technical parameters		EMDC-64M
Power supply		
Supply voltage/tolerance/	AC 230 V (50 - 60 Hz)/	
Rated current:	-15/+10 %/max. 100 mA	
DALI power supply:	16 V, 250 mA	
Dissipated power:	max. 3 W	
Communication		
Input interface:	EBM BUS (RS485 communication)	
Output interface:	DALI (max. 64 ballasts) DMX (max. 32 receivers, with repeater up to 64)	
Indication		
Power supply:	green LED Un	
Error surge or short DALI:	illuminated red LED ERR	
Indication of unit status:	LED DALI/DMX (see iNELS installation handbook)	
Operating conditions		
Relative humidity:	max. 80 %	
Operating temperature:	-20 °C to +55 °C	
Storage temperature:	-30 °C to +70 °C	
Protection degree:	IP20 device, IP40 mounting in the switchboard	
Control device purpose:	operating control device	
Control device construction:	individual control device	
Characteristic of automatic action:	2.5 kV	
Overvoltage category:	II.	
Pollution degree:	2	
Operating position:	vertical	
Installation:	into switchboard on DIN rail EN60715	
Implementation:	3-MODULE	
Dimension and weight		
Dimension:	90 x 52 x 65 mm	
Weight:	140 g	

- The unit EMDC-64M is designed to control DALI electronic ballasts and DMX receivers from the iNELS system.
- EMDC-64M enables control of up to 64 independent electronic ballasts DALI (Digital Addressable Lighting Interface) for fluorescent lamps, LEDs and other light sources.
- EMDC-64M also enables connection of up to 64 DMX receivers (Digital MultipleX).
- Control from iNELS BUS System via EBM BUS.
- DIP switches on the front panel to select the control interface (DALI/DMX).
- Addressing of DALI ballast units can be done via the central unit and iDM3.
- The required functionality is set in user project in iDM3 software.
- The unit EMDC-64M is powered from the mains voltage 230 V AC.
- DALI BUS power supply is 16 V/250 mA via an EMDC-64M unit.
- The system BUS EBM is galvanically separated from the BUSes DALI/DMX. Terminals for connecting the DALI BUS are equipped with short circuit and surge protection.
- If this concerns the last unit on a system BUS EBM, it is necessary to terminate the wire with a resistor with nominal resistance of 120 Ω. The resistor is inside the unit, termination is made by shorting neighboring terminals TERM and EBM+.
- The BUS DMX must be terminated at its end by a resistor with nominal resistive value 120 Ω. The resistor for DMX BUS termination is on the side of the EMDC-64M inside the unit, termination is performed by shorting adjacent terminals TERM and A.
- Updating the firmware of the EMDC-64M can be done through the central unit and software iDM3.
- When configuring DALI addresses two types are necessary to distinguished:
 - MASTER - this group includes sensors and detectors and one DALI branch can connect up to 4 DALI MASTER units
 - lighting intensity sensor DLS3-1
 - motion detector DMD3-1
 - SLAVE - electronic lighting ballast
- EMDC-64M in 3-MODULE design is designed for mounting in a control panel on a DIN rail EN60715.

Connection

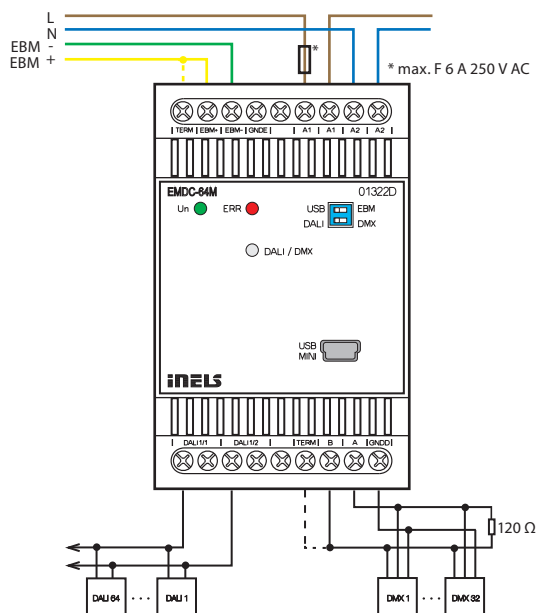



EAN code
MCD3-01: 8595188191234

Technical parameters		MCD3-01
Inputs		
HF system:	5.8 GHz CW radar, ISM band	
Detection angle:	360°	
Reach:	2-10 m (radius.), adjustable	
Time setting:	in iDM software	
Recommended installation height:	2.5 - 3 m	
Changing the sensitivity:	yes (in hardware)	
Light metering:	yes (in hardware)	
Communication		
Terminals:	0.3 - 0.8 mm ²	
Interface:	installation iNELS BUS	
Power supply		
From iNELS BUS:	27 V DC, -20/+10 %, 20 mA	
Operating conditions		
Work temperature:	-10 to 40 °C	
Operation position:	free	
Installation:	ceiling/surface	
Dimension and weight		
Dimension:	115 x 24 mm	

- The MCD3-01 is a highly versatile and compact motion sensor designed for ceiling or surface mounting applications. With its ultra-slim design, the MCD3-01 seamlessly integrates into various environments, providing reliable and efficient motion detection capabilities.
- The sensor is powered by a 27 VDC power source, specifically the iNELS BUS system, ensuring stable and efficient operation.
- The MCD3-01 utilizes a 5.8 GHz continuous wave (CW) radar system operating in the ISM band, offering precise and reliable motion detection.
- The sensor provides a wide 360-degree detection angle, ensuring comprehensive coverage of the monitored area.
- The sensor's reach is adjustable, allowing the user to set the detection range. The reach can be configured within the range of 2 to 10 meters in radius, providing flexibility for different applications.
- The MCD3-01 features a software setting for adjusting time settings. The time setting can be configured, allowing customization of the sensor's activation duration.
- Designed to operate effectively in various environmental conditions, the sensor has a wide working temperature range of -10°C to +40°C, ensuring reliable performance in different settings.
- The MCD3-01 can be seamlessly integrated and combined with other iNELS units using the iDM3 software. This allows for the implementation of additional logics and functions, enabling automation and customized control scenarios based on specific requirements.
- The MCD3-01 features a compact form factor with dimensions of 115 x 24 mm, facilitating easy installation and integration into different ceiling or surface mounting applications.



Connection

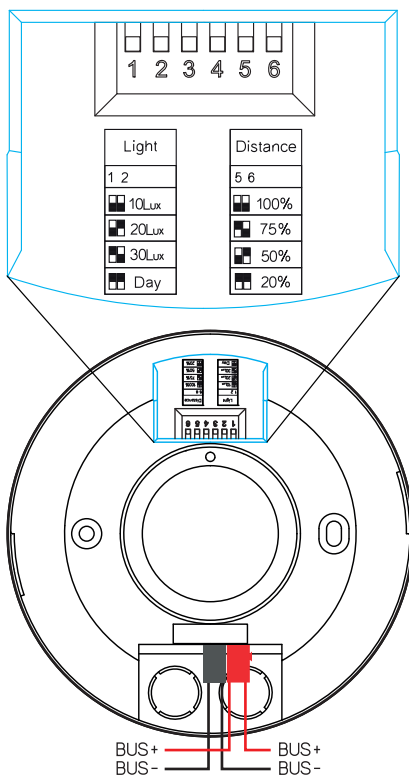



EAN code
PMS3-01: 8595188191357

Technical parameters		PMS3-01
Inputs		
Detection angle:		360°
Time setting:		in iDM software
Recommended installation height:		2.5 - 3.5 m
Luminance control:		yes (in hardware)
Communication		
Terminals:		0.3 - 0.8 mm ²
Interface:		installation iNELS BUS
Power supply		
From iNELS BUS:		27 V DC, -20/+10 %, 20 mA
Operating conditions		
Work temperature:		-10 to 40 °C
Operation position:		free
Installation:		ceiling/surface
Dimension and weight		
Dimension:		115 x 24 mm

Connection

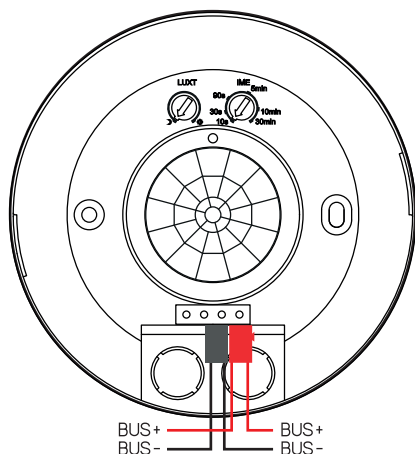

- The PMS3-01 is a highly versatile and compact motion sensor designed for ceiling or surface mounting applications. With its ultra-slim design, the PMS3-01 seamlessly integrates into various environments, providing reliable and efficient motion detection capabilities.
- The sensor is powered by a 27 VDC power source, specifically the iNELS BUS system, ensuring stable and efficient operation.
- The PMS3-01 utilizes an infrared for precise and reliable motion detection.
- The sensor provides a wide 360-degree detection angle, ensuring comprehensive coverage of the monitored area.
- The sensor's reach is up to 6m max, allowing the user to install the unit at a height of 2.5 m-3.5 m, providing flexibility for different applications.
- The PMS3-01 features a software setting for adjusting time settings. The time setting can be configured, allowing customization of the sensor's activation duration.
- Designed to operate effectively in various environmental conditions, the sensor has a wide working temperature range of -10°C to +40°C, ensuring reliable performance in different settings.
- The PMS3-01 can be seamlessly integrated and combined with other iNELS units using the iDM3 software. This allows for the implementation of additional logics and functions, enabling automation and customized control scenarios based on specific requirements.
- The PMS3-01 features a compact form factor with dimensions of 115 x 24 mm, facilitating easy installation and integration into different ceiling or surface mounting applications.





EAN code
DLS3-1: 8595188157506

Technical parameters		DLS3-1
Inputs		
Range of measurement of lighting:	1 - 100 000 lx	
Detection angle:	40 °	
Outputs		
Indication red LED:	identification DALI MASTER/setting indication	
Indication green LED RUN:	communications/unit status	
Communication		
Interface:	installation iNELS BUS, DALI	
Power supply		
From iNELS BUS:	27 V DC, -20/+10 %	
Rated current:	12 mA (27 V DC)	
From DALI BUS:	16 V (max. 23 V)	
Rated current:	20 mA (16 V DC)	
Dissipated power:	max. 0.5 W	
Connection		
Terminals:	max. 1x2.5, max. 2x1.5/with sleeve max. 1x2.5 mm ²	
Operating conditions		
Operating temperature:	-30 to +60 °C	
Storing temperature:	-30 to +70 °C	
Protection degree:	IP65	
Operating position:	vertical	
Dimension and weight		
Dimension:	96 x 62 x 34 mm	
Weight:	100 g	

For proper function of the detector it is necessary to eliminate all sources of light interference in the sensing area.

- The luminescence sensor DLS3-1 is for sensing the current luminescence at the point of installation of the unit.
- The DLS3-1 sensor is equipped with two communication interfaces:
 - iNELS BUS installation
 - DALI (a maximum 4 pcs of DMD3-1 or DLS3-1 units can be used on one DALI bus).
- Information about the current value of the light intensity can be used in tasks of maintaining constant luminescence. In space where it is possible, thanks to the contribution of natural light from the outside to adjust the artificial light, which can reduce energy consumption.
- Thanks to the DLS3-1 units cannot only be used in residential projects, but also in commercial projects, offices or manufacturing plants, warehouses.
- The DLS3-1 unit is recommended to be installed so that the luminescence sensor for sensing faces down and should not be exposed to direct radiation.
- Setting up a communication interface with DIP switches no. 1:
 - in the upper position determines the communication interface DALI
 - in the lower position determines the communication interface iNELS.
- The DLS3-1 detector is powered directly via the iNELS BUS installation (nominal 27 V DC) or DALI BUS (nominal 16 V DC).
- The unit can be configured via iNELS3 Designer & Manager software, which, amongst other things it is possible to:
 - Set the desired functions according to the detected illumination.
 - The sensing range is 1-100 000 lux.
 - The DLS3-1 unit is supplied in IP65 and so can be installed in the outdoor environment.

Connection

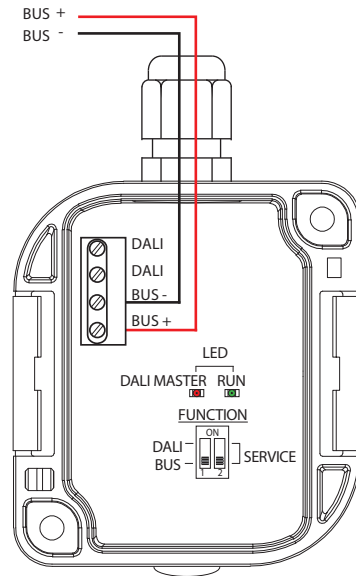



EAN code
ADC3-60M: 8595188133012

Technical parameters ADC3-60M

Input	
Analog inputs:	6x voltage, current or temperature input
Number of inputs:	6
Galv. separation from inner circuits:	no
Diagnostic:	indication (exceeding the range, interruption of a sensor or overload of Uref output) by the applicable red LED
Common terminal:	COM
Converter resolution:	14 bits
Input resistance	
- for voltage ranges:	approx. 150 k Ω
- for current ranges:	100 Ω
Types of inputs/measuring ranges*:	Voltage (U): 0 \div +10 V (U) ; 0 \div +2 V (U) Current (I) : 0 \div +20 mA (I) ; 4 \div +20 mA (I) temperature: input at ext. temperature sensor TC, TZ see accessories/according to used sensor from -40 $^{\circ}$ C to 125 $^{\circ}$ C

Outputs of the Uref1 and Uref2 voltage

Voltage**/current of Uref1:	10 or 15 V DC/100 mA
Voltage**/current of Uref2:	10 V DC/20 mA

Communication

Installation BUS:	BUS
Unit status indication:	green LED RUN

Power supply

Supply voltage/tolerance:	27 V DC, -20/+10 %
Dissipated power:	max. 1 W
Rated current:	100 mA (at 27 V DC), from BUS

Connection

Terminal:	max. 2.5 mm ² /1.5 mm ² with sleeve
-----------	---

Operating conditions

Operating temperature:	-20 to +55 $^{\circ}$ C
Storing temperature:	-30 to +70 $^{\circ}$ C
Protection degree:	IP20 device, IP40 mounting in the switchboard
Overvoltage category:	II.
Pollution degree:	2
Operating position:	any
Installation:	into a switchboard rail to DIN EN 60715
Design:	3-MODULE

Dimensions and weight

Dimensions:	90 x 52 x 65 mm
Weight:	112 g

* selectable for each input/output individually by configuration in the user program iDM3. Min. supply voltage 24 V DC must be respected when configuring 15 V DC and 100 mA consumption.

** according to load Uref output.

- ADC3-60M is an analog-to-digital converter and is equipped with 6 analog inputs.
- Analog inputs serve to connect temperature sensors or analog sensors that generates current or voltage signal.
- The analog inputs have a resolution of a 14-bit AD converter.
- The analog inputs have a common terminal COM.
- Analog inputs/outputs are configurable in iDM3 independently as voltage (U) or current (I) or temperature.
- We recommend Clima sensor as a meteo station. There are four types: five to eight outputs. The top series offers measuring of: rainfall, brightness, twilight, speed of wind, temperature and relative humidity.
- The red LEDs in the front panel indicate exceeding the range, interruption of a sensor or overload of Uref output.
- The temperature inputs at the top of the terminal are used to connect the following temperature sensors: TC, TZ.
- ADC3-60M in 3-MODULE version is designed for mounting into a switch-board, on a DIN rail EN60715.

Connection

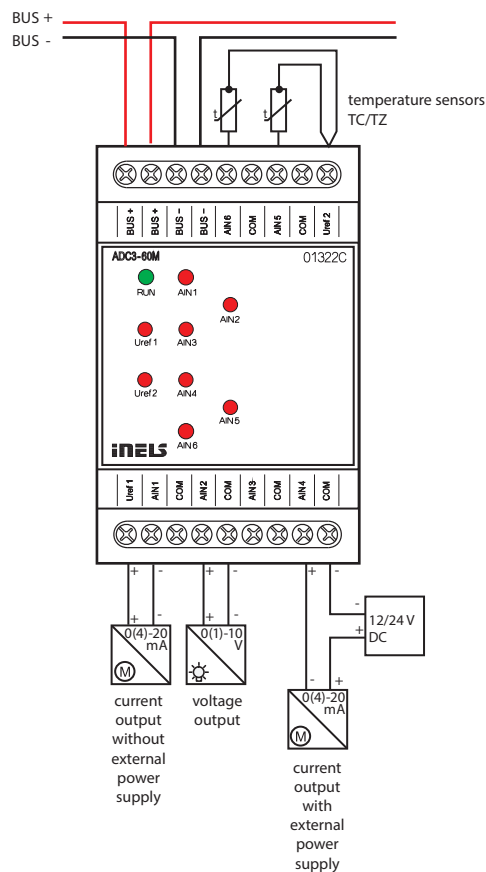



EAN code
DAC3-04M: 8595188132565

Technical parameters **DAC3-04M**

Input	
Temperature measuring:	yes, input for external temperature sensor TC/TZ
Range/accuracy of temp. measuring:	-20 to +120 °C; 0.5 °C from the range
Outputs	
Analog voltage output/rated current:	4x 0(1)-10 V/10 mA
Indication of output overload:	red LED OVERLOAD
Communication	
Installation BUS:	BUS
Status indication unit:	green LED RUN
Power supply	
Supply voltage/tolerance:	27 V DC, -20/+10 %
Dissipated power:	max. 1 W
Rated current:	50 mA (at 27 V DC), from BUS
Connection	
Terminal:	max. 2.5 mm ² /1.5 mm ² with sleeve
Operating conditions	
Air humidity:	max. 80 %
Operating temperature:	-20 to +55 °C
Storing temperature:	-30 to +70 °C
Protection degree:	IP20 device, IP40 mounting in the switchboard
Overvoltage category:	II.
Pollution degree:	2
Operating position:	any
Installation:	switchboard on DIN rail EN 60715
Design:	3-MODULE
Dimensions and weight	
Dimensions:	90 x 52 x 65 mm
Weight:	108 g

- DAC3-04M is a converter from a digital signal to an analog voltage signal.
- The converter generates 4 analog voltage signals, which can be operated, according to type of controlled device, in a range 0-10 V or 1-10 V.
- This is used for regulating and controlling devices that may be controlled by this signal (dimnable ballasts of fluorescent lamps and other types of light sources - e.g. LED panels from the assortment of ELKO Lighting, dimming actuator for LED and RGB strips RFDA-73M/RGB, thermo drives, servo drives, elements for measuring and regulation and others).
- Range of output voltage is adjustable in iDM3.
- Converter is equipped with a temperature input for connecting a 2-wire external sensor TC/TZ (see accessories).
- DAC3-04M in 3-MODULE version is designed for mounting into a switchboard, on DIN rail EN60715.

Connection

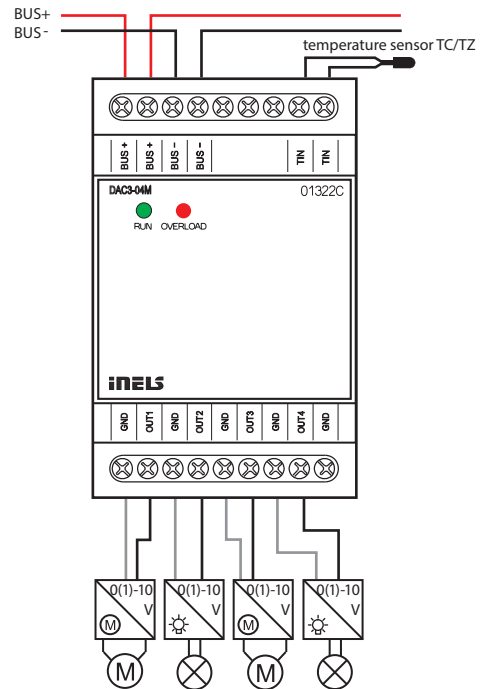

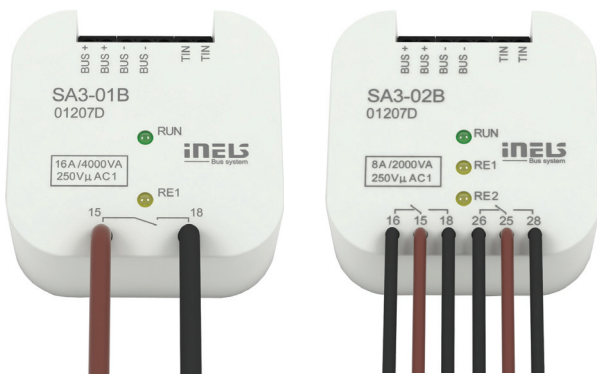

EAN code
SA3-01B: 8595188132350
SA3-02B: 8595188132367

Technical parameters	SA3-01B	SA3-02B
Inputs		
Temperature measuring:	Yes, input for external thermo sensor TC, TZ	
Scope and accuracy of tem.meas.:	-20 to +120°C; 0.5°C from the range	
Outputs		
Output:	1x switching 16 A/AC1	2x changeover 8 A/AC1
Switching voltage:	250 V AC, 24 V DC	
Switched load:	4000 VA/AC1, 384 W/DC	2000 VA/AC1, 192 W/DC
Surge current:	30 A; max. 4 s. when repeating 10%	10 A
Output relays separated from all internal circuits:	reinforced insulation (Cat. II surges by EN 60664-1)	
Insulation voltage between relay outputs RE1-RE2:	x	basic isolation (Cat. II surges by EN 60664-1)
Minimal switching current:	100 mA/5 V	
Switching frequency/no load:	1200 min ⁻¹	300 min ⁻¹
Switching frequency/rated load:	6 min ⁻¹	15 min ⁻¹
Mechanical lifetime:	3x 10 ⁷	1x 10 ⁷
Electrical lifetime for AC1:	0.7x 10 ⁵	1x 10 ⁵
Output indication:	yellow LED	2x yellow LED
Communication		
Installation BUS:	BUS	
Power supply		
Supply voltage/tolerance:	27 V DC, -20/+10 %	
Dissipated power:	max. 4 W	
Rated current:	30 mA (at 27 V DC)	50 mA (at 27 V DC)
Status indication unit:	green LED RUN	
Connection		
Data terminals:	terminal, 0.5 - 1 mm ²	
Power outputs:	2x conduct. CY, Ø 2.5 mm ²	6x conduct. CY, Ø 0.75 mm ²
Operating conditions		
Operating temperature:	-20 to +55 °C	
Storage temperature:	-30 to +70 °C	
Protection degree:	IP30	
Overvoltage category:	II.	
Pollution degree:	2	
Operating position:	any	
Installation:	into installation box	
Dimensions and weight		
Dimensions:	49 x 49 x 21 mm	
Weight:	50 g	50 g

- Actuators are designed for switching of one (SA3-01B), respectively two (SA3-02B) of various appliances and loads by relay outputs (potentialless contacts).
- SA3-01B contains 1 relay with switching potentialless contact with max. load 16 A/4000 VA/AC1.
- SA3-02B contains 2 relays with switching potentialless contacts with max. load 8 A/2000 VA/AC1.
- Output contacts are separately controllable and addressable.
- Thanks to changeover contacts, the SA3-02B actuator can be used to control a 230 V drive (such as blinds, shutters or awnings), whereas by proper bridging of contacts, it is possible to secure locking hardware options while switching on phase two outputs.
- Actuators are equipped with a temperature input for connecting an external two-wire temperature sensor TC/TZ (see accessories).
- LED on front panel signals state of each output.
- SA3 is normally supplied in the option AgSnO₂ contact material.
- SA3-01B, SA3-02B are designed for mounting into the installation box.

Connection

SA3-01B

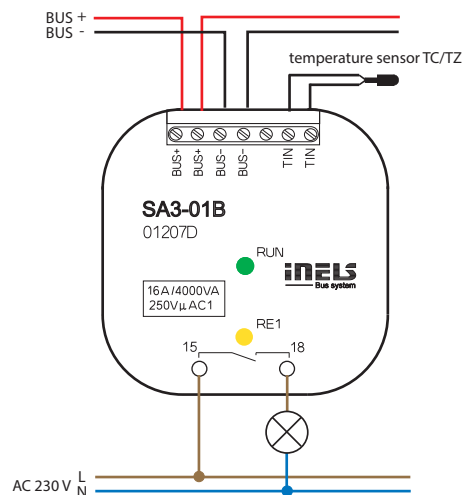

SA3-02B

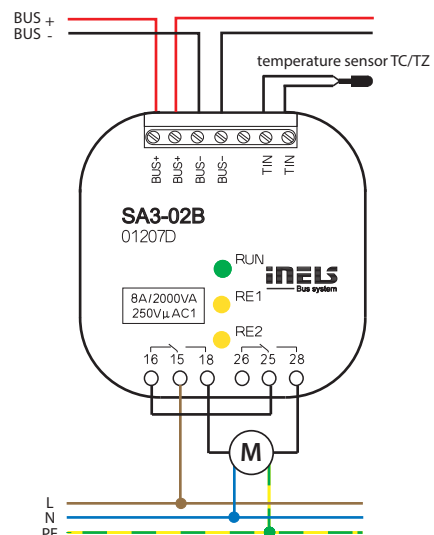



EAN code
SA3-04M: 8595188132381

Technical parameters SA3-04M

Outputs	
Output:	4x changeover 16 A/AC1
Switching voltage:	250 V AC, 24 V DC
Switching output:	4000 VA/AC1, 384 W/DC
Surge current:	30 A; max. 4 s. at 10% duty cycle
Output relays separated from all internal circuits:	reinforced insulation (Cat. II surges by EN 60664-1)
Isolation between relay outputs RE1-3 and RE4:	reinforced insulation (Cat. II surges by EN 60664-1)
Isolation between relay outputs RE1-3:	basic insulated (Cat. II surges by EN 60664-1)
Isolates. voltage open relay contact:	1 kV
Min. switched current:	100 mA
Switching frequency/no load:	1200 min ⁻¹
Switching frequency/rated load:	6 min ⁻¹
Mechanical life:	3x 10 ⁷
Electrical life AC1:	0.7x 10 ⁵
Output indication:	4x yellow LED

Communication

Installation BUS:	BUS
-------------------	-----

Power supply

Supply voltage/tolerance:	27 V DC, -20/+10 %
Dissipated power:	max. 4 W
Rated current:	70 mA (at 27 V DC), from BUS
Status indication unit:	green LED RUN

Connection

Terminal:	max. 2.5 mm ² /1.5 mm ² with sleeve
-----------	---

Operating conditions

Air humidity:	max. 80 %
Operating temperature:	-20 to +55 °C
Storing temperature:	-30 to +70 °C
Protection degree:	IP20 device, IP40 mounting in the switchboard
Overvoltage category:	II.
Pollution degree:	2
Operation position:	any
Installation:	switchboard on DIN rail EN 60715
Design:	3-MODULE

Dimensions and weight

Dimensions:	90 x 52 x 65 mm
Weight:	164 g

- SA3-04M is a switching actuator containing 4 independent relays with changeover potential-free contacts.
- Maximum load per contact is 16 A/4000 VA/AC1.
- Each of the 4 outputs contacts are individually controllable and addressable.
- All four relays are individually decorated input terminals, and therefore can switch various independent potentials.
- The actuator is designed for switching 4 various appliances or loads by relay outputs (potential free contacts).
- Thanks to changeover contacts, it can be used to control up to two drives 230 V power (such as blinds, shutters or awnings) with appropriate bridging, the contacts can secure hardware blocking the possibility of simultaneous switching of the phase on both outputs, see example of connection.
- LEDs on the front panel signal the status of each output.
- Contact status of each relay can be changed separately and manually by control buttons on a front panel.
- Switching actuators SA3 is normally supplied in the option AgSnO₂ contact material.
- SA3-04M in 3-MODULE version is designed for mounting into a switchboard, on DIN rail EN60715.

Connection

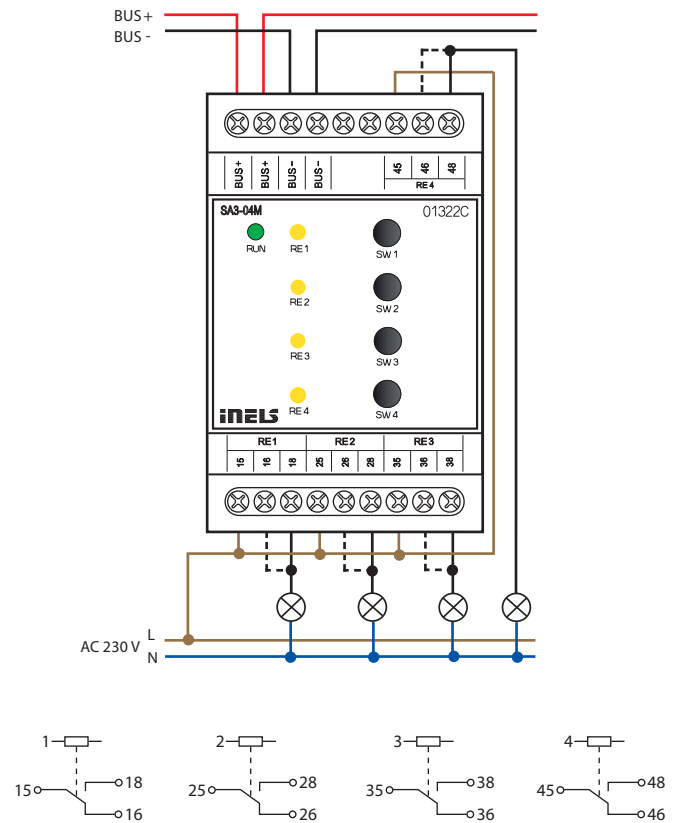



EAN code
SA3-06M: 8595188132879

Technical parameters

SA3-06M

Outputs

Output:	6x changeover 8 A/AC1
Switching voltage:	250 V AC, 24 V DC
Switching output:	2000 VA/AC1, 192 W/DC
Surge current:	10 A
Output relays separated from all internal circuits:	reinforced insulation (Cat. II surges by EN 60664-1)
Isolation between relay outputs COM1 and COM2:	reinforced insulation (Cat. II surges by EN 60664-1)
Isolation between individual relay outputs:	basic insulated (Cat. II surges by EN 60664-1)
Isolates voltage open relay contact:	1 kV
Max. current terminals COM1 and COM2:	16 A
Min. switched current:	100 mA/5 V DC
Switching frequency/no load:	300 min ⁻¹
Switching frequency/rated load:	15 min ⁻¹
Mechanical life:	2x 10 ⁷
Electrical life AC1:	5x 10 ⁴
Output indication:	6x yellow LED

Communication

Installation BUS:	BUS
-------------------	-----

Power supply

Supply voltage/tolerance:	27 V DC, -20/+10 %
Dissipated power:	max. 9 W
Rated current:	60 mA (at 27 V DC), from BUS
Status indication unit:	green LED RUN

Connection

Terminal:	max. 2.5 mm ² /1.5 mm ² with sleeve
-----------	---

Operating conditions

Air humidity:	max. 80%
Operating temperature:	-20 to +55 °C
Storing temperature:	-30 to +70 °C
Protection degree:	IP20 device, IP40 mounting in the switchboard
Overvoltage category:	II.
Pollution degree:	2
Operation position:	any
Installation:	switchboard on DIN rail EN 60715
Design:	3-MODULE

Dimensions and weight

Dimensions:	90 x 52 x 65 mm
Weight:	160 g

- The actuator is designed for switching up to six various appliances and loads with potentialless contact.
- SA3-06M is a switching actuator contains 6 independent relays with changeover potentialless contacts.
- Maximum load per contact is 8 A/2000 VA/AC1.
- Each of six output contacts are individually controllable and addressable.
- The relays are divided into two groups, the group of four relays on the bottom terminal switches the common potential, a pair of relays on top of the terminal switches the second common potential.
- The actuator is suitable for operating discontinuously controlled thermo drives in the distributor of floor heating.
- LEDs on the front panel signals the status of each output.
- Contact status of each relay can be changed separately and manually by control buttons on a front panel.
- SA3-06M is normally supplied in the option AgSnO₂ contact material.
- SA3-06M in 3-MODULE version is designed for mounting into a switchboard/DIN rail EN60715.

Connection

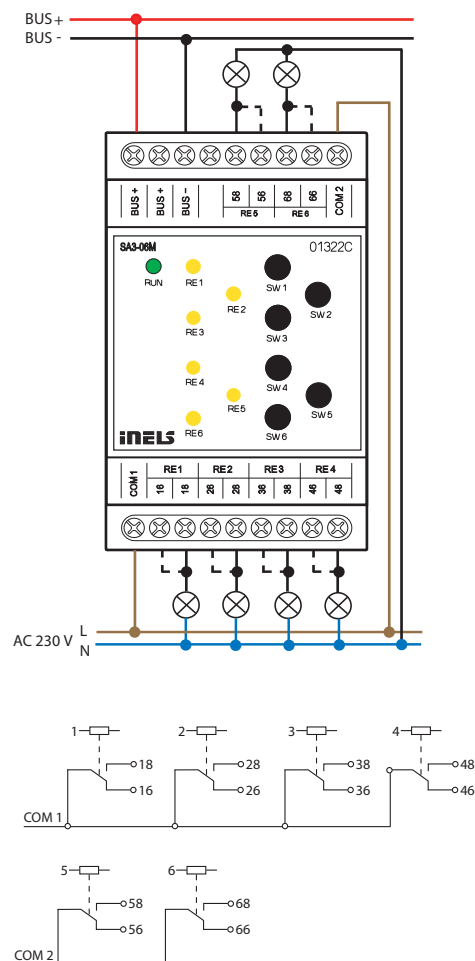



EAN code
SA3-014M: 8595188191241
SA3-014M/E: 8595188189178

Technical parameters	SA3-014M	SA3-014M/E
Outputs		
Output:	14x switching 10 A/AC1	
Switched voltage:	250 V AC, 30 V DC	
Switched output:	2500 VA/AC, 150 W/DC	
Peak current:	10 A	
Output relays separated from all internal circuits:	reinforced insulation (Cat. II surges by EN 60664-1)	
Isolation between relay outputs COM 1,2 COM 3,4 COM 5,6 COM 7,8 COM 9,10 COM 11,12:	reinforced insulation (Cat. II surges by EN 60664-1)	
Isolates. voltage open relay contact:	1 kV	
Max. current of one common terminal:	12 A	
Minimal switched current:	100 mA/10 V DC	
Switching frequency without load:	300 min ⁻¹	
Switching frequency with rated load:	15 min ⁻¹	
Mechanical life:	1x 10 ⁷	
Electrical life AC1:	1x 10 ⁵	
Mains voltage detection:	yes (relay switching in zero)	
Communication		
Installation BUS:	BUS	
Status indication unit:	green LED RUN - status led for relay only RUN LED	
Power supply		
Voltage of BUS/tolerance/nominal current:	27 V DC, -20/+10 %, 150 mA	
Connection		
Terminal:	max. 2.5 mm ² /1.5 mm ² with sleeve	
Operating conditions		
Operating temperature:	-20 to +55 °C	
Storing temperature:	-30 to +70 °C	
Protection degree:	IP20 device, IP40 mounting in the switchboard	
Overvoltage category:	II.	
Pollution degree:	2	
Operating position:	any	
Installation:	switchboard on DIN rail EN 60715	
Design:	6-MODULE	
Dimensions and weight		
Dimensions:	90 x 105 x 65 mm	
Weight:	310 g	

- SA3-014M is a switching actuator containing 14 independent relays with NO potentialless contacts, with the fact that switches the same potential. Maximal loadability of contacts is 10A/2500 VA/AC1.
- Each of the fourteen output contacts are individually controllable and addressable. Actuator SA3-014M is powered by an bus voltage 27V DC.
- The unit's status is indicated by the green RUN LED on the front panel - if the bus supply is connected, but there is no communication via BUS with master, the LED RUN is on continuously.
 - if the bus voltage is connected and the unit communicates by BUS, the LED RUN flashes.
- LEDs on the front panel signals the status of each output. Contact status of each relay can be changed separately and manually by control buttons on a front panel.
- The unit has synchronized closing and opening of the relay in the zero-voltage of the sinusoidal waveform. The sync inputs are COM 1, 3, 5, 7, 9, 11 and 13 against the N terminal.
- SA3-014M is normally supplied in the option AgSnO2 contact material. SA3-014M in design 6-MODULE is designed to be mounted into a switchboard, on to DIN rail EN60715.
- **SA3-014M/E comes with an economic option without manual control buttons on the front panel and status LEDs for the relay output.**

Connection (SA3-014M/E)

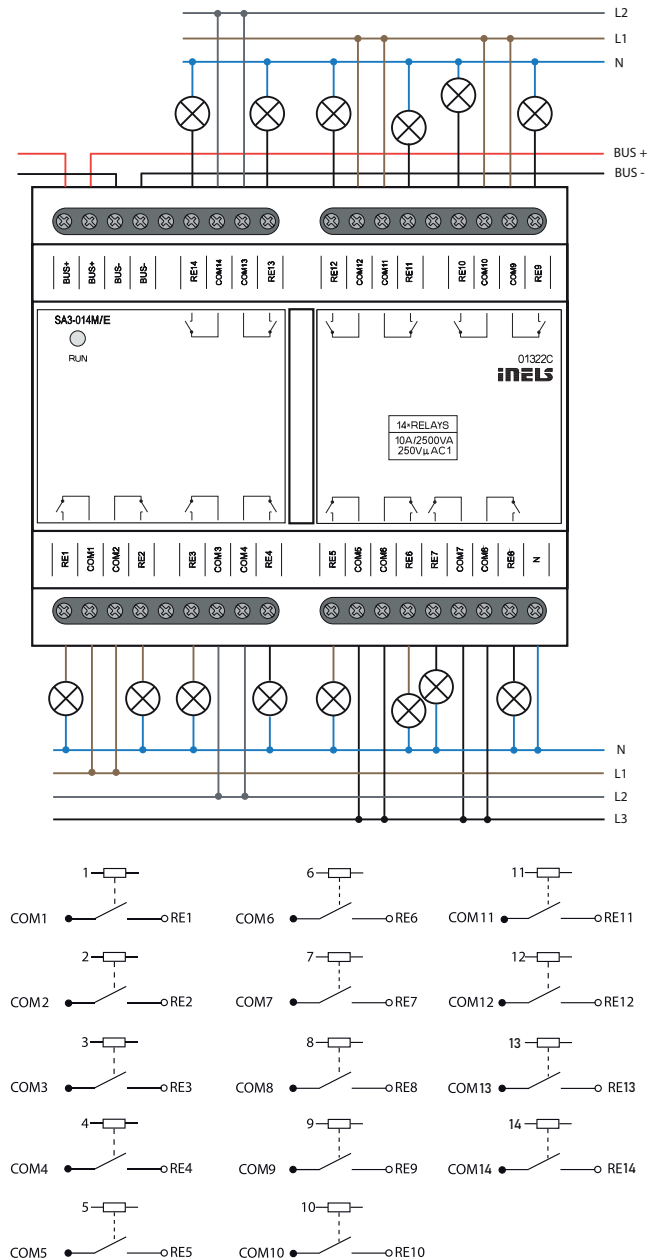

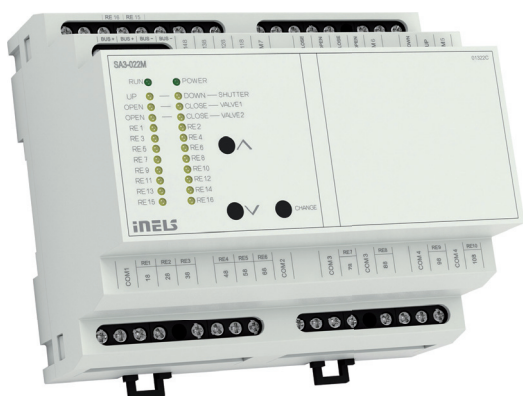

EAN code
SA3-022M: 8595188135269

Technical parameters

SA3-022M

Outputs

Output indication:	yellow LED
Output relays separated from all internal circuits:	reinforced insulation (Cat. II surges by EN 60664-1)
Insulation between COM potentials:	reinforced insulation (Cat. II surges by EN 60664-1)
Isolates. voltage open relay contact:	1 kV
SSR (Electronic Relay):	4x switching (VALVE1–VALVE2)
Switching voltage:	20 - 240 V AC
Switching output:	480 VA
Surge current:	20 A, $t \leq 16$ ms
Relay 6A:	12x switching (RE1 - RE6, RE11 - RE16), 1x HW block changeover (OUT1, OUT2)
Switching voltage:	250 V AC, 24 V DC
Switching output:	1500 VA/AC1; 300 VA/AC15; 180 W/DC, AC3
Minimum switching load:	500 mW (12 V/10 mA)
Mechanical life:	10×10^6
Electrical life AC1:	6×10^4
Relay 10A:	4x switching (RE7 - RE10)
Switching voltage:	250 V AC, 24 V DC
Switching output:	2500 VA/AC1, 240 W/DC
Surge current:	30 A max. 4 s at 10%
Minimal switched current:	100 mA
Switching frequency without load:	1200 min^{-1}
Switching frequency with rated load:	6 min^{-1}
Mechanical life:	3×10^7
Electrical life AC1:	0.7×10^5
Communication	
Installation BUS:	BUS
Unit status indication:	green LED POWER
Power supply	
Supply voltage/tolerance:	27 V DC, -20/+10 %
Dissipated power:	max. 3 W
Rated current:	100 mA (at 27 V DC), from BUS
Power status indication:	green LED RUN
Connection	
Terminal:	max. 2.5 mm ² /1.5 mm ² with sleeve
Operating conditions	
Operating temperature:	-20 to +55 °C
Storing temperature:	-30 to +70 °C
Protection degree:	IP20 device, IP40 mounting in the switchboard
Overvoltage category:	II.
Pollution degree:	2
Operating position:	any
Installation:	switchboard on DIN rail EN 60715
Design:	6-MODULE
Dimensions and weight	
Dimensions:	90 x 105 x 65 mm
Weight:	307 g

- Equipped with 22 relay outputs (of which 1x changeover contact – roller blinds, blinds).
- Switch lighting and socket circuits (6 A and 10 A relay) with common potential at the "COMx" terminal.
- Control of roller blinds, blinds (24 - 230 V AC/DC).
- Relay control of the fan coil unit - heating/cooling, 3 fan speeds (24 - 230 V AC/DC).
- Connection to BUS, communication with CU3.
- The front panel LEDs indicate the status of each output.
- SA3-022M in design 6-MODULE is designed to be mounted into a switchboard, onto DIN rail EN60715.

Connection

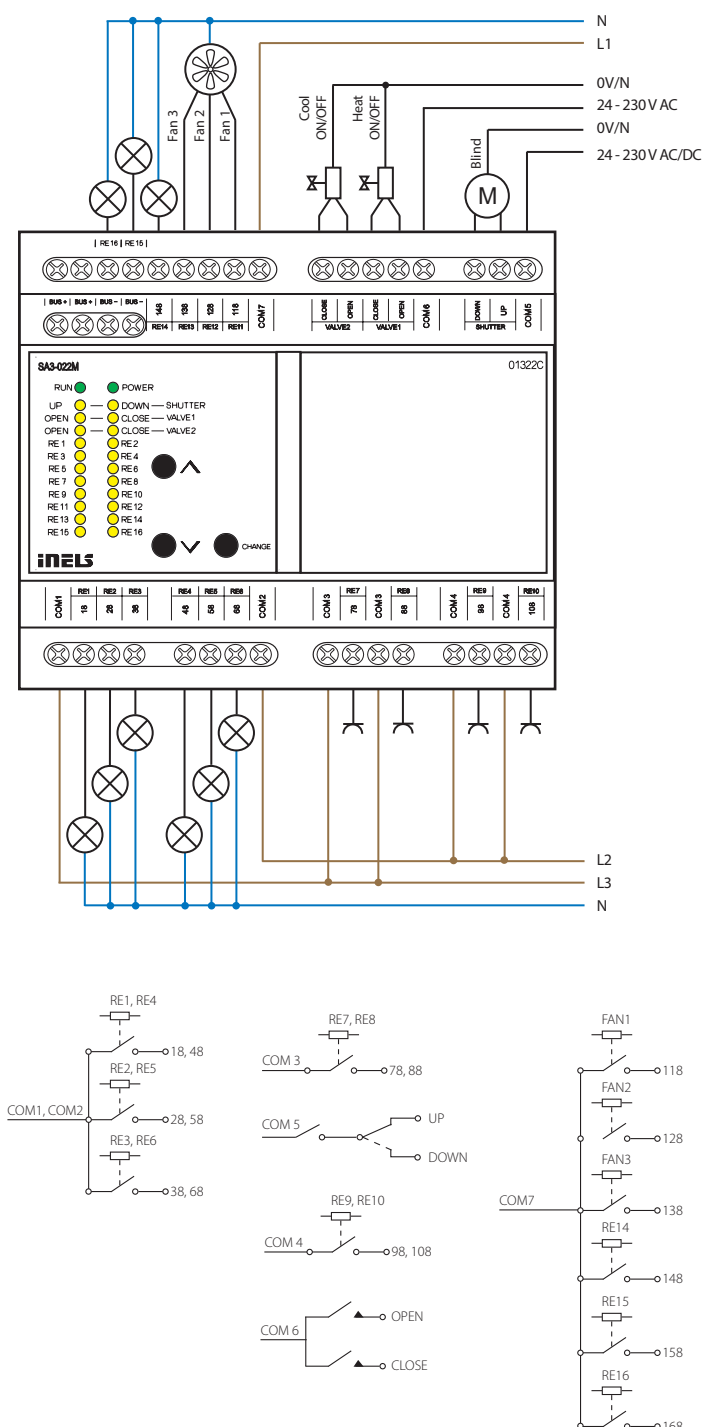

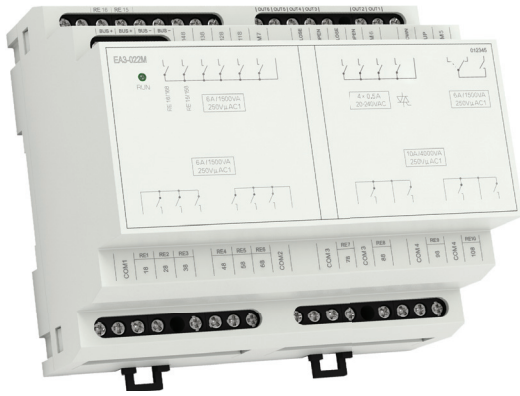

- Equipped with 22 relay outputs (of which 1x changeover contact – roller blinds, blinds).
- Switch lighting and socket circuits (6 A and 10 A relay) with common potential at the "COMx" terminal.
- Control of roller blinds, blinds (24 - 230 V AC/DC).
- Relay control of the fan coil unit - heating/cooling, 3 fan speeds (24 - 230 V AC/DC).
- Connection to BUS, communication with CU3.
- EA3-022M in design 6-MODULE is designed to be mounted into a switchboard, onto DIN rail EN60715.

EAN code
EA3-022M: 8595188135238

Technical parameters EA3-022M

Outputs

Output relays separated from all internal circuits:	reinforced insulation (Cat. II surges by EN 60664-1)
Insulation between COM potentials:	reinforced insulation (Cat. II surges by EN 60664-1)
Isolates. voltage open relay contact:	1 kV
SSR (Electronic Relay):	4x switching (VALVE1-VALVE2)
Switching voltage:	20 - 240 V AC
Switching output:	480 VA
Surge current:	20 A, t ≤ 16 ms
Relay 6 A:	12x switching (RE1 - RE6, RE11 - RE16), 1x HW block changeover (OUT1, OUT2)
Switching voltage:	250 V AC, 24 V DC
Switching output:	1500 VA/AC1; 300 VA/AC15; 180 W/DC, AC3
Minimum switching load:	500 mW (12 V/10 mA)
Mechanical life:	10x10 ⁶
Electrical life AC1:	6x10 ⁴
Relay 10 A:	4x switching (RE7 - RE10)
Switching voltage:	250 V AC, 24 V DC
Switching output:	2500 VA/AC1, 240 W/DC
Surge current:	30 A max. 4 s at 10 %
Minimal switched current:	100 mA
Switching frequency without load:	1200 min ⁻¹
Switching frequency with rated load:	6 min ⁻¹
Mechanical life:	3x 10 ⁷
Electrical life AC1:	0.7x 10 ⁵

Communication

Installation BUS:	BUS
Unit status indication:	green LED RUN

Power supply

Supply voltage/tolerance:	27 V DC, -20/+10 %
Dissipated power:	max. 2 W
Rated current:	100 mA (at 27 V DC), from BUS

Connection

Terminal:	max. 2.5 mm ² /1.5 mm ² with sleeve
-----------	---

Operating conditions

Operating temperature:	-20 to +55 °C
Storing temperature:	-30 to +70 °C
Protection degree:	IP20 device, IP40 mounting in the switchboard
Overtoltage category:	II.
Pollution degree:	2
Operating position:	any
Installation:	switchboard on DIN rail EN 60715
Design:	6-MODULE

Dimensions and weight

Dimensions:	90 x 105 x 65 mm
Weight:	337 g

Connection

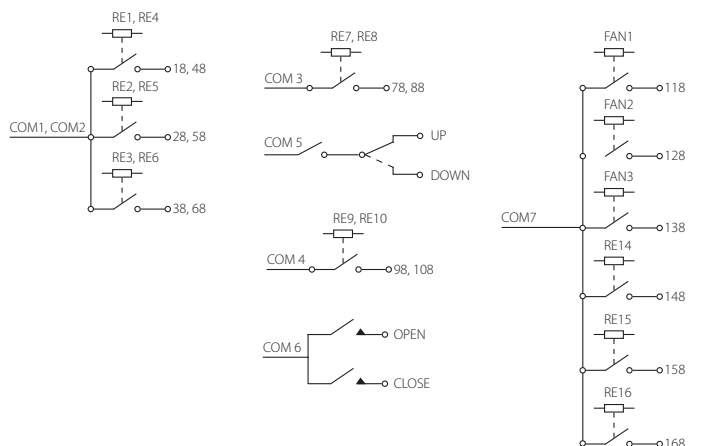
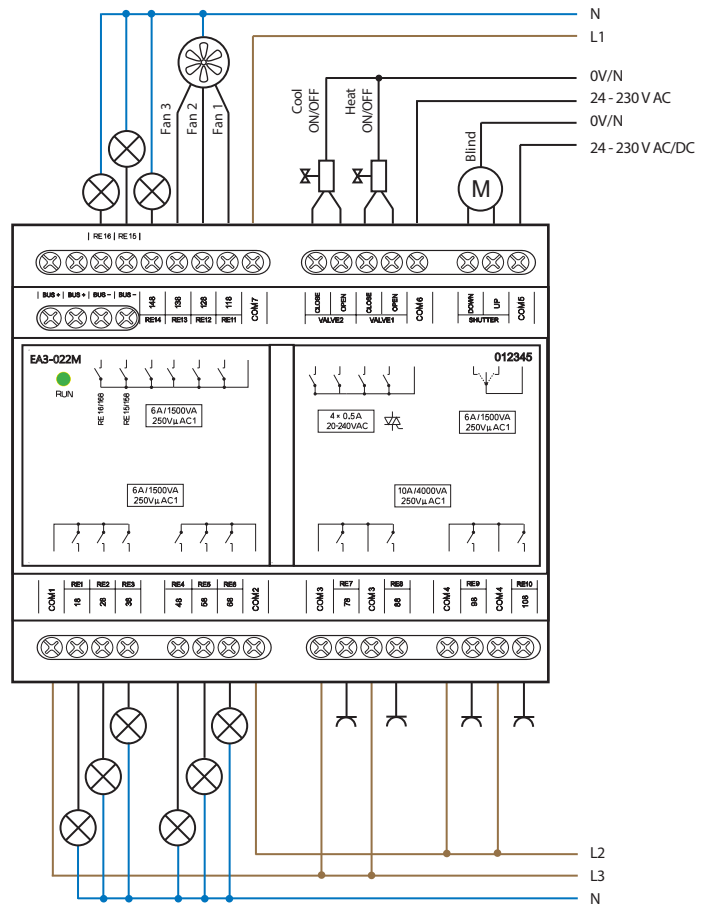



EAN code
JA3-014M: 8595188191258
JA3-014M/E: 8595188189491

Technical parameters	JA3-014M	JA3-014M/E
----------------------	----------	------------

Outputs	JA3-014M	JA3-014M/E
---------	----------	------------

Output:	14x switching 0.5 A/AC15	
Switched voltage:	250 V AC, 30 V DC	
Switched output:	125 VA/AC15	
Peak current:	10 A	
Output relays separated from all internal circuits:	reinforced insulation (Cat. II surges by EN 60664-1)	
Isolation between relay outputs COM 1,2 COM 3,4 COM 5,6 COM 7,8 COM 9,10 COM 11,12:	reinforced insulation (Cat. II surges by EN 60664-1)	
Isolates. voltage open relay contact:	1 kV	
Max. current of one common terminal:	12 A	
Minimal switched current:	100 mA/10 V DC	
Switching frequency without load:	300 min ⁻¹	
Switching frequency with rated load:	15 min ⁻¹	
Mechanical life:	1x 10 ⁷	
Electrical life AC1:	1x 10 ⁵	
Mains voltage detection:	yes (relay switching in zero)	

Communication	JA3-014M	JA3-014M/E
---------------	----------	------------

Installation BUS:	BUS	
Status indication unit:	green LED RUN - status led for relay only RUN LED	

Power supply	JA3-014M	JA3-014M/E
--------------	----------	------------

Voltage of BUS/tolerance/nominal current:	27 V DC, -20/+10 %, 150 mA	
---	----------------------------	--

Connection	JA3-014M	JA3-014M/E
------------	----------	------------

Terminal:	max. 2.5 mm ² /1.5 mm ² with sleeve	
-----------	---	--

Operating conditions	JA3-014M	JA3-014M/E
----------------------	----------	------------

Operating temperature:	-20 to +55 °C	
Storing temperature:	-30 to +70 °C	
Protection degree:	IP20 device, IP40 mounting in the switchboard	
Overvoltage category:	II.	
Pollution degree:	2	
Operating position:	any	
Installation:	switchboard on DIN rail EN 60715	
Design:	6-MODULE	

Dimensions and weight	JA3-014M	JA3-014M/E
-----------------------	----------	------------

Dimensions:	90 x 105 x 65 mm	
Weight:	310 g	

- JA3-014M is an actuator designed for controlling rollers, shutters, blinds, awnings, garage doors, entrance gates, etc.
- It controls electric drives that are controlled in two directions and have a built-in limit switch.
- The unit's status is indicated by the green RUN LED on the front panel
 - if the BUS voltage is connected, but there is no communication via BUS with master, the LED RUN is on continuously.
 - if the bus voltage is connected and the unit communicates by BUS, the LED RUN flashes.
- LEDs on the front panel signals the status of each output.
- Contact status of each relay can be changed separately and manually by control buttons on a front panel.
- The software blocking of output relay contacts can be secure using the iNELS Design Manager software.
- JA3-014M is normally supplied in the option AgSnO2 contact material.
- JA3-014M/E in 6-MODULE version is designed for mounting into a switchboard on DIN rail EN60715.
- **JA3-014M/E comes with an economic option without manual control buttons on the front panel and status LEDs for the relay output.**

Connection

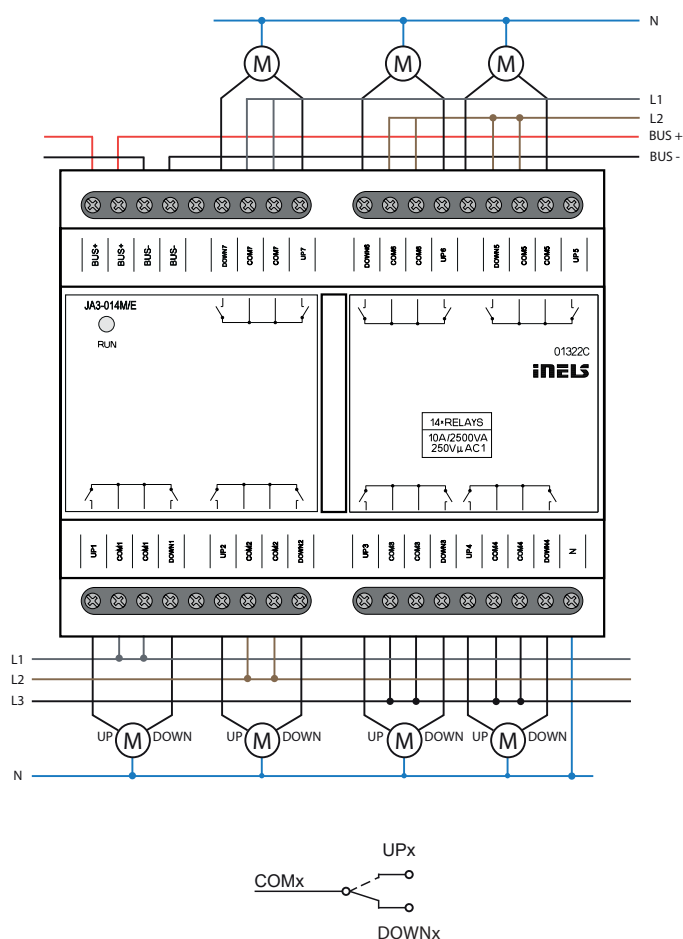



EAN code
DA3-22M: 8595188132626
DA3-22M/120V: 8595188133036

Technical parameters	DA3-22M	DA3-22M/120V
Inputs		
Input:	2x inputs, switching potential L*	
Temperature measuring:	YES, input for external thermo sensor TC/TZ	
Scope and accuracy of temp. measurement:	-20 to +120 °C; 0.5 °C from the range	
Number of control buttons:	2x buttons 4x potentiometers on front panel	
Outputs		
Output:	2x contactless outputs, 2x MOSFET	
Load type:	resistive, inductive, capacitive**, LED, ESL	
Isolation BUS separated from all internal circuits:	reinforced insulation (Cat. II surges by EN 60664-1)	
Isolation voltage between particular power:	max. 500 V AC	
Minimal controlled load:	10 VA	
Maximal controlled load:	400 VA for each channel	200 VA for each channel
Output indication ON/OFF:	2x yellow LED	
Device protection:	thermal/short-term overload/ long-term overload	
Communication		
Installation BUS:	BUS	
Power supply		
Supply voltage by BUS/ tolerance:	27 V DC, -20/+10 %	
Rated current:	5 mA (at 27 V DC), from BUS	
Status indication unit:	green LED RUN	
Supply voltage for power section/tolerance:	AC 230 V (50 Hz), -15/+10 %	AC 120 V (60 Hz), -15/+10 %
Dissipated power:	max. 13 W	max. 7.5 W
Connection		
Terminal:	max. 2.5 mm ² /1.5 mm ² with sleeve	
Operating conditions		
Air humidity:	max. 80 %	
Operating temperature:	-20 to +35 °C	
Storing temperature:	-30 to +70 °C	
Protection degree:	IP20 device, IP40 mounting in the switchboard	
Overvoltage category:	II.	
Pollution degree:	2	
Operating position:	vertical	
Installation:	switchboard on DIN rail EN 60715	
Design:	3-MODULE	
Dimensions and weight		
Dimensions:	90 x 52 x 65 mm	
Weight:	170 g	

* The inputs are not galvanically isolated from the supply voltage.

** **Attention:** It is not allowed to connect loads of inductive and capacitive character, at the same time.

⚠ Input is connected to the mains voltage potential.

- DA3-22M is a universal dimming 2-fold actuator enabling control of brightness intensity of dimmable light sources of the type ESL, LED and RLC with power supply 230 V.
- DA3-22M has two MOSFET controlled outputs 230 V AC, maximum load is 2x 400 VA.
- Option of connecting an external temperature sensor.
- Each output channel is independently controllable and addressable.
- Type of light source is set by a switch on the front panel.
- By setting the min. brightness potentiometer on the front panel, flashing of different types of light sources is eliminated.
- DA3-22M is equipped with two inputs 230 V AC, which can be controlled by mechanical switches (buttons, relays). Inputs are galvanically connected to potential L, which is permanently at the terminals IN1 and IN2.
- By clicking on buttons on the front panel you can manually switch on or off the corresponding output.
- Electronic overcurrent and thermal protection - switch off output in case of overload short circuit and overheating.
- The power supply (potential L) must be protected by a protective element corresponding to the power input of the connected load, e.g. a safety fuse.
- During installation, it is necessary to leave on each side of the actuator at least half the module space for better cooling.
- DA3-22M in 3-MODULE version is designed for mounting into a switch-board on DIN rail EN60715.

Connection

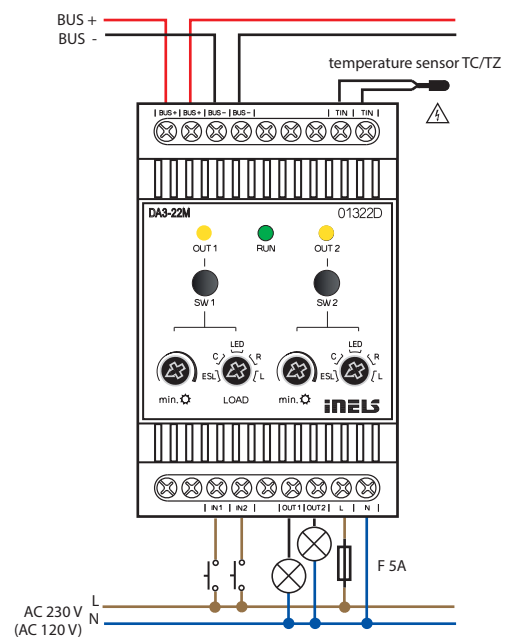

Types of connectable loads

type of source	symbol	description
R resistive	HAL 230V	ordinary light bulb, halogen lamp
L inductive	HAL 12-24V	coiled transformer for low-voltage halogen lamps
C capacitive	HAL 12-24V	electronic transformer for low-voltage halogen lamps
LED	HAL 12-24V	LED lamps and LED light sources, 230 V
ESL	HAL 12-24V	dimnable energy-saving fluorescent tubes



EAN code
 DA3-66M / 230: 8595188182065
 DA3-66M / 120: 8595188174459

Technical parameters DA3-66M/230V DA3-66M/120V

Outputs	
Output:	6x contactless outputs, 2x MOSFET / channel
Load type: *	R-resistive, L-inductive, C-capacitive, LED, ESL - economical
Minimal controlled load:	10 VA
Maximal controlled load:	DA3-66M / 230V: 150 VA for each channel DA3-66M / 120V: 75 VA for each channel possibility of parallel connection of outputs
Output indication ON/OFF:	6x yellow LED
Device protection:	thermal/short-term overload/ long-term overload

Inputs	
Wire buttons:	6x galvanically separated
Input voltage:	20-230 AC(50-60 Hz)/DC
Isolation voltage:	between inputs max. 230 VAC/DC (basic insulation) to all other internal circuits: reinforced insulation: overvoltage category II
Maximum cable length:	10 m
Glow plug connection:	no

Communication	
Installation BUS:	BUS
Power supply	
Supply voltage by BUS/ tolerance:	27 V DC, -20/+10 %
Rated current:	100 mA (at 27 V DC), from BUS
Status indication unit:	green LED RUN
Supply voltage for power section/tolerance:	AC 230 V (50-60 Hz), -15/+10 % AC 120 V (50-60 Hz), -15/+10 %

Connection	
Terminal:	max. 2.5 mm ² /1.5 mm ² with sleeve

Operating conditions	
Air humidity:	max. 80 %
Operating temperature:	-20 to +50 °C
Storing temperature:	-30 to +70 °C
Protection degree:	IP20 device, IP40 mounting in the switchboard
Overvoltage category:	II.
Pollution degree:	2
Operating position:	vertical
Installation:	switchboard on DIN rail EN 60715
Design:	6-MODULE

Dimensions and weight	
Dimensions:	90 x 105 x 65 mm
Weight:	320 g

* **Attention:** It is not allowed to connect loads of inductive and capacitive character, at the same time.

- DA3-66M is a universal dimming 6-channels actuator, which is used to control the brightness of dimmable light sources such as ESL, LED and RLC with 230 V power supply.
- The DA3-66M has 6 semiconductor controlled 230 V AC outputs. The maximum possible load is 150 VA for each channel.
- The individual outputs of the dimmer can be connected in parallel and thus increase the maximum output load at the expense of the number of outputs.
- Each output channel is independently controllable and addressable.
- By setting min. brightness, the flickering of different types of light sources is eliminated.
- Min. brightness and type of load is performed using SW IDM.
- Use the control buttons on the front panel to manually control the output.
- The actuator is equipped with electronic overcurrent and thermal protection, which switches off the output in case of overload, short circuit, over-heating.
- The dimmer has 6 galvanically separated inputs which can be used both to control the dimmer and as a binary input to the iNELS system.
- The the device supply (potential L) must be protected with a safety device corresponding to the power input of the connected load, e.g. with a quick-release fuse.
- During installation, it is necessary to leave at least half a module of free space on each side of the actuator for better cooling.
- DA3-66M is in 6-MODULE version and is intended for mounting in a switch-board on DIN rail EN60715.

Connection

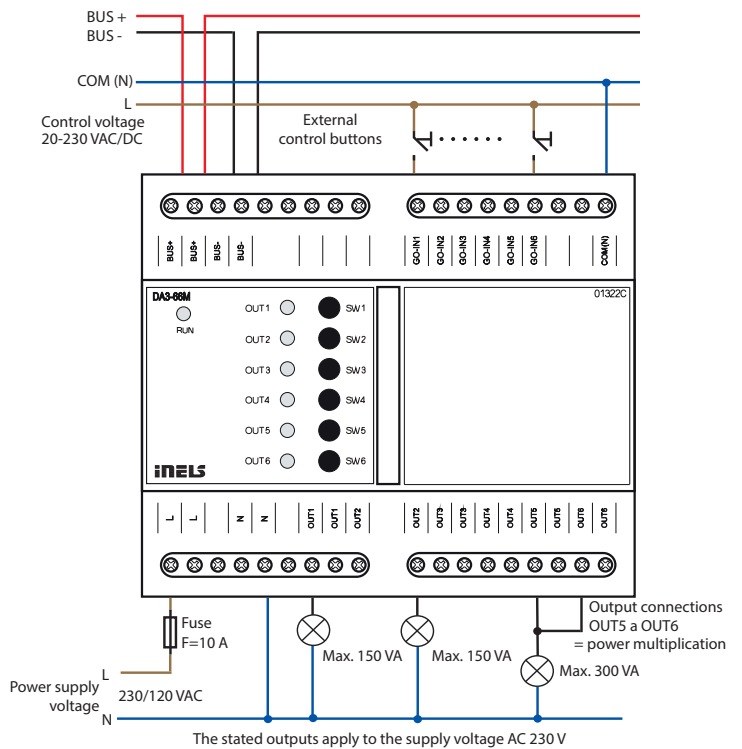

Types of connectable loads

type of source	symbol	description
R resistive		ordinary light bulb, halogen lamp
L inductive		coiled transformer for low-voltage halogen lamps
C capacitive		electronic transformer for low-voltage halogen lamps
LED		LED lamps and LED light sources, 230 V
ESL		dimmable energy-saving fluorescent tubes



EAN code
DA3-03/RGBW: 8595188184632

Technical parameters		DA3-03M/RGBW
Output		
Dimmable load:	LED strip 12 V, 24 V, 48 V; RGBW LED strip 12 V, 24 V, 48 V	
Number of channels:	3x 4	12x 1
Surge current:	3x 15 A	12x 3,75 A
Switching voltage:	0–50 V DC stabilized	
Dimmable performance:	max. 400 W	
Communication		
Installation BUS:	BUS	
Power supply		
Supply voltage by BUS/ tolerance:	27 V DC, -20/+10 %	
Rated current:	5 mA (from 27 V DC), from BUS	
Status indication unit:	green LED RUN	
Connection		
Terminal:	max. 2.5 mm ² /1.5 mm ² with sleeve	
Operating conditions		
Air humidity:	max. 80 %	
Operating temperature:	-20 to +35 °C	
Storing temperature:	-30 to +70 °C	
Protection degree:	IP20 device, IP40 mounting in the switchboard	
Overvoltage category:	II.	
Pollution degree:	2	
Operating position:	vertical	
Installation:	switchboard on DIN rail EN 60715	
Design:	3-MODULE	
Dimensions and weight		
Dimensions:	90 x 52 x 65 mm	
Weight:	170 g	

- The dimmer for LED strips is used for independent control of 12 channels, so it can be connected to, for example:

3 RGB led strips

3 RGB led strips + 2 single colour strips

12 single colour LED strips

- The 3-module design of the device with mounting in the switchboard allows the connection of a dimmable load of 3x 15 A or 12x 3.75 A, which represents, for example: 3 pieces of RGBW LED strips 24 V 20W/m = max 18m.
- The dimmer is controlled by the central unit of the iNELS system.
- The power supply of the LED strip is in the range of 0-50V DC.
- Each of the output channels is separately controllable and addressable.
- The actuator is equipped with electronic thermal protection, which switches off the output in case of overheating.
- During installation, it is necessary to leave at least half a module of free space on each side of the actuator for better cooling.
- DA3-03M/RGBW in 3-MODUL design is intended for installation in a switchboard on an EN60715 DIN rail.

Connection

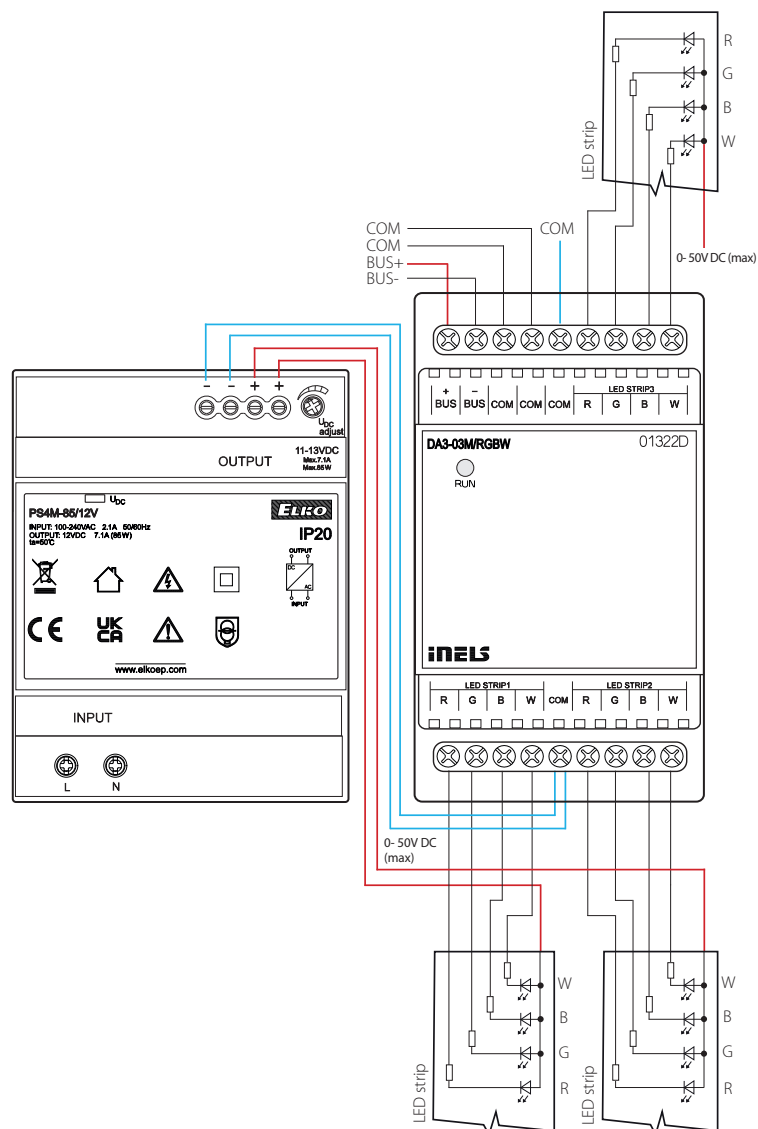

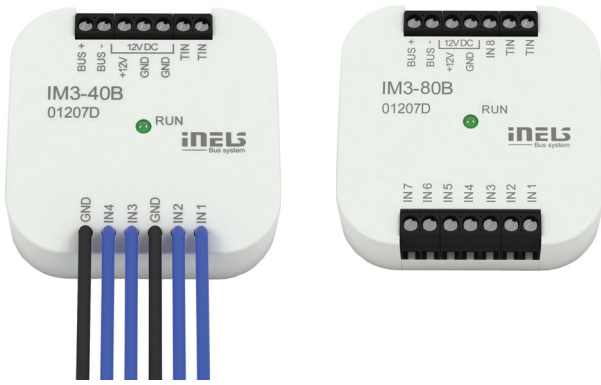

EAN code
 IM3-40B: 8595188132312
 IM3-80B: 8595188132329

Technical parameters	IM3-40B	IM3-80B
Inputs		
Input:	4x* IN1, IN2**	8x* IN1- IN5**
Max. frequency pulse reading:	20 Hz	
Temperature measuring:	yes, input for external thermo sensor TC/TZ	
Range/accuracy of thermomeasuring:	-20 to +120 °C/0.5 °C from the range	
Outputs		
Output voltage/current:	12 V DC/75 mA, for supplying EZS sensors	
Communication		
Installation BUS:	BUS	
Status indication unit:	green LED RUN	
Power supply		
Supply voltage/tolerance:	27 V DC, -20/+10 %	
Dissipated power:	max. 1 W	
Rated current:	20 mA (at 27 V DC), from BUS	
Rated current of unit for full load on output 12 V DC:	60 mA	100 mA
Connection		
Terminal:	0.5-1 mm ²	
Inputs:	6x conductors CY length 90 mm	x
Operating conditions		
Operating temperature:	-20 to +55 °C	
Storing temperature:	-30 to +70 °C	
Protection degree:	IP30	
Overvoltage category:	II.	
Pollution degree:	2	
Operating position:	any	
Installation:	into installation box	
Dimensions and weight		
Dimensions:	49 x 49 x 13 mm	
Weight:	32 g	27 g

* NO or NC against GND(-)
 ** are balanced inputs

- Binary input units IM3-40B and IM3-80B are used for connection of 4 or 8 devices with potential-less contacts (switches, buttons, switches of other design, PIR detectors, fire and gas detectors, etc.).
- Part of the inputs can be used as a balanced for alarm detectors:
 - IM3-40B – inputs IN1, IN2
 - IM3-80B – inputs IN1 – IN5
- Contacts of external devices connected to the inputs of the unit can be NO or NC - input parameters are configured in the software iDM3.
- Within the internal ESS configured in the iDM3 software, inputs must be set to balance or double balance.
- The units generate a supply voltage of 12 V DC/75 mA for powering external intrusion detectors, so they can power PIR detectors, fire and gas detectors.
- Active use 12 V DC output for powering detectors increases the nominal consumption of units from BUS (see technical data).
- The units can be used for counting pulses of energy meters with pulse output.
- The units are equipped with a temperature input for connecting an external two-wire temperature sensor TC/TZ (see accessories).
- IM3-40B, IM3-80B in case type B are designed for mounting into a installation box.

Connection

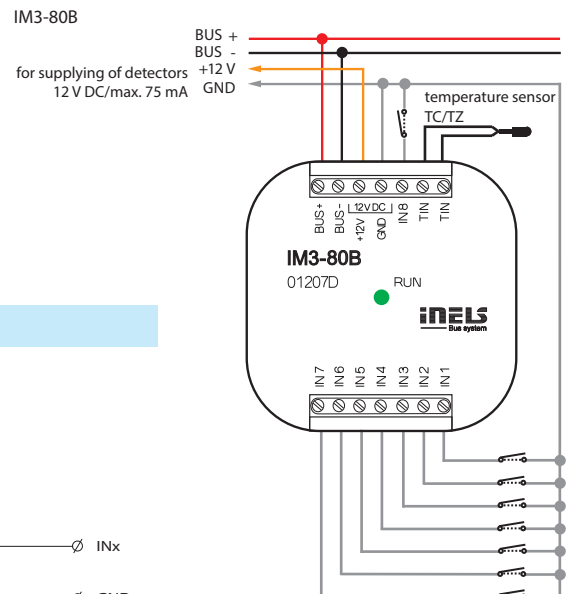
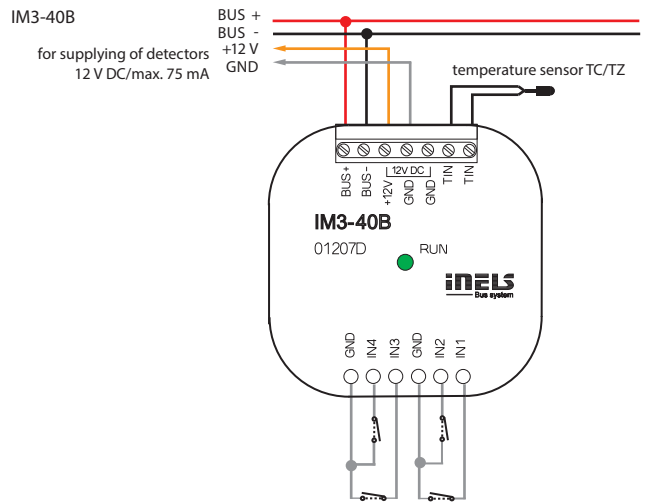

Balanced input

Simple:

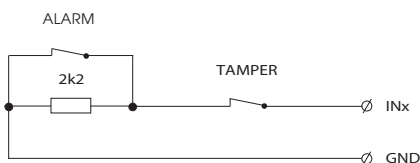

Double:

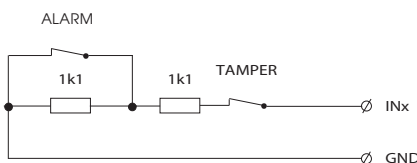



EAN code
IM3-140M: 8595188132459

Technical parameters **IM3-140M**

Inputs

Input:	14x NO or NC against GND (-) IN1 - IN7 - are balanced inputs
Max. frequency pulse reading:	20 Hz

Outputs

Output (power supply 12 V for sensors):	12 V DC/150 mA
---	----------------

Communication

Installation BUS:	BUS
Data transfer indication:	green LED

Power supply

Supply voltage/tolerance:	27 V DC, -20/+10 %
Dissipated power:	max. 1 W
Rated current:	25 mA (at 27 V DC), from BUS
Rated current for full load on output 12 V DC:	100 mA

Connection

Terminal:	max. 2.5 mm ² /1.5 mm ² with sleeve
-----------	---

Operating conditions

Air humidity:	max. 80 %
Operating temperature:	-20 to +55 °C
Storing temperature:	-30 to +70 °C
Protection degree:	IP20 device, IP40 mounting in the switchboard
Overvoltage category:	II.
Pollution degree:	2
Operating position:	any
Installation:	into a switchboard rail to DIN EN 60715
Design:	3-MODULE

Dimensions and weight

Dimensions:	90 x 52 x 65 mm
Weight:	104 g

- Binary input unit IM3-140M is designed to connect up to 14 devices with potentialless contact (such as switches, buttons of other designs, fire and glass detectors and others).
- Inputs IN1 - IN7 can be balanced.
- Contacts of external devices connected to the inputs of the drive can be NO or NC - Input parameters are configured in the software iDM3.
- Inputs must be configured as balanced or double balanced - in an internal Electronic security system configured in iDM3 software.
- The unit generates a supply voltage of 12 V DC/150 mA for powering external detectors, so it can power PIR detectors, fire and gas detectors.
- Active use 12 V DC output for powering detectors increases the nominal consumption units from BUS (see technical data).
- The unit can be used for counting pulses of energy meters with pulse output.
- IM3-140M in 3-MODULE is designed for switchboard mounting on DIN rail EN60715.

Connection

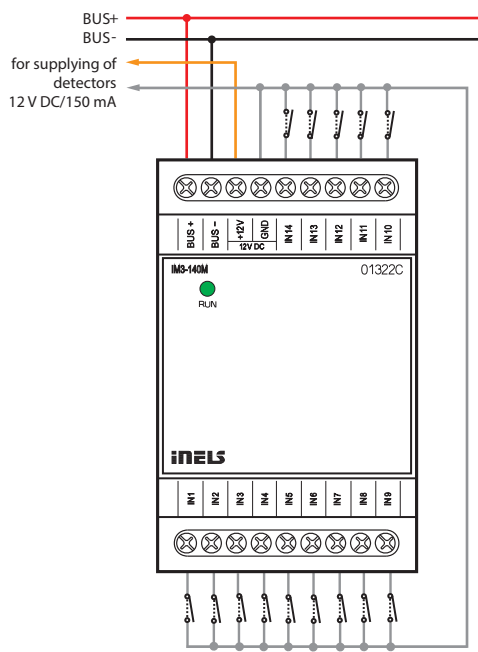

Balanced input

Simple:

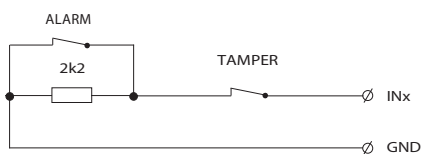

Double:

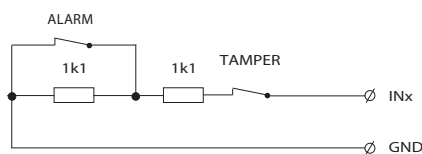



EAN code
TI3-40B: 8595188132695

Technical parameters **TI3-40B**

Input	
Temperature input for temperature measuring:	4x inputs for external thermo sensor*
Temperature measurement range:	by type of sensor, prob from -50°C to 400°C
Converter resolution:	15 bit
Communication	
Installation BUS:	BUS
Status indication unit:	green LED RUN
Power supply	
Supply voltage/tolerance:	27 V DC, -20/+10 %
Dissipated power:	max. 1 W
Rated current:	20 mA (at 27 V DC), from BUS
Connection	
Terminal:	0.5 mm ² - 1 mm ²
Operating conditions	
Operating temperature:	-20 to +55 °C
Storing temperature:	-30 to +70 °C
Protection degree:	IP30
Overvoltage category:	II.
Pollution degree:	2
Operating position:	any
Installation:	into installation box
Dimensions and weight	
Dimensions:	49 x 49 x 13 mm
Weight:	27 g

*TC, TZ, Ni1000, Pt1000, Pt100, see accessories

Connection options

2-wire
- it is necessary to connect terminals TIN_B and COM

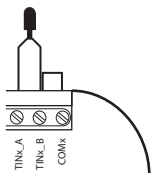

3-wire
- connection of the sensor needs to be done according to the technical specifications

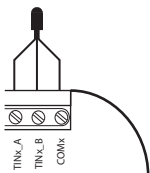

- The unit is designed for connection of up to four (TI3-40B) external temperature sensors.
- Units range TI3 support the connection of the following temperature sensors:
 - TC/TZ - 2-wire connections
 - Ni1000, Pt1000, Pt100 - 2-wire and 3-wire connections
- Used in when necessary to take temperatures from different places (for example large floor heating – diagonal layout of sensors, floor/space, indoor/outdoor temperature, technological device – boiler, solar heating etc.)
- Status of units indicated by green RUN LED on the front panel:
 - if the supply voltage is connected (units are powered via the BUS), but there is no communication with the master, RUN LED is lit continuously.
 - if the supply voltage is connected and the unit communicates via standard BUS, RUN LED flashes.
- TI3-40B in version B is designed for mounting into an installation box.

Connection

TI3-40B

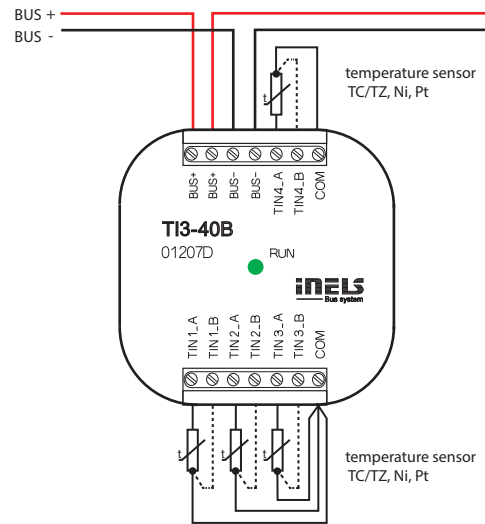

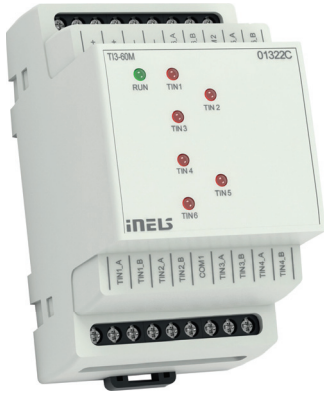

EAN code
TI3-60M: 8595188132893

Technical parameters **TI3-60M**

Inputs

Temperature input for temperature measuring:	6x input for external temperature sensor TC, TZ, Ni1000, Pt1000, Pt100 see accessories
Temperature measurement range:	by type of sensor, probe from -50°C to 400°C
Converter resolution:	15 bit
Indication of exceeding the range or interruption of the sensor:	6x red LED

Communication

Installation BUS:	BUS
Status indication unit:	green LED RUN

Power supply

Supply voltage/tolerance:	27 V DC, -20/+10 %
Dissipated power:	max. 1 W
Rated current:	45 mA (at 27 V DC), from BUS

Connection

Terminal:	max. 2.5 mm ² /1.5 mm ² with sleeve
-----------	---

Operating conditions

Operating temperature:	-20 to +55 °C
Storing temperature:	-30 to +70 °C
Protection degree:	IP20 device, IP40 mounting in the switchboard
Overvoltage category:	II.
Pollution degree:	2
Operating position:	any
Installation:	into a switchboard rail to DIN EN 60715
Design:	3-MODULE

Dimensions and weight

Dimensions:	90 x 52 x 65 mm
Weight:	111 g

Connection options

2-wire
- it is necessary to connect terminals TIN_B and COM

3-wire
- connection of the sensor needs to be done according to the technical specifications

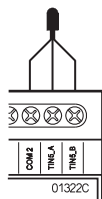
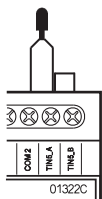

- Unit TI3-60M is designed to connect up to six external temperature sensors.
- Units range TI3 support the connection of the following temperature sensors:
 - TC/TZ - 2-wire connections
 - Ni1000, Pt1000, Pt100 - 2-wire and 3-wire connections
- It is used in cases where it is necessary to read the temperature, eg floor/room, indoor/outdoor temperature, process equipment - boiler, solar heating, etc.
- Unit status is indicated by green RUN LED on the front panel:
 - if the supply voltage is connected (the unit is powered via the BUS), but there is no communication with the master, RUN LED is lit continuously.
 - if the supply voltage is connected and the unit communicates via standard BUS, RUN LED flashes.
- The status on individual temperature inputs is indicated by the relevant red LED on the front panel:
 - LIT - temperature sensor disconnection
 - FLASHES - exceeding of the temperature range
 - UNLIT - ok
- TI3-60M in 3-MODULE is designed for switchboard mounting on DIN rail EN60715.

Connection

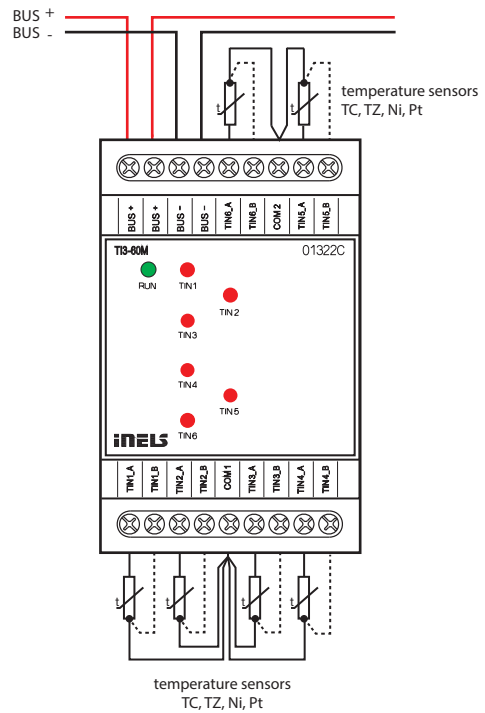

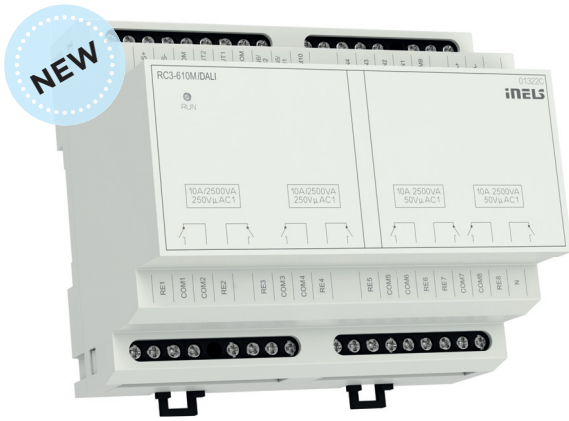

EAN code
RC3-610M/DALI: 8595188184663

Technical parameters		RC3-610M/DALI
Output		
Relay		8x NO/switch 10 A/AC1
Switched voltage:		250VAC , 30VDC
Switched power:		2500 VA/AC1, 150 W/DC
Peak current:		10A AC1 , 5A DC
Relay outputs separated from of all internal circuits:		reinforced insulation (Overvoltage cat. II according to EN 60664-1)
Isolation between COM1,2 a COM3,4 a COM5,6,7,8 *		basic insulation (cat. overvoltage II according to EN 60664-1) max. 400AC
Isolation voltage of the open relay contact:		1 kV
Max. current through one common terminal:		16 A
Minimum switching current:		100 mA/10 V DC
Mechanical service life:		10 000 000
Electrical life AC1:		100 000
Analog		
Analog outputs:		AO1, AO2
Voltage analogue. output/ max. current:		2x 0(1) - 10 V/10 mA
Inputs		
Input DIN:		6x DIN (digital input) or 4x DIN + 2x TIN (temperature input) **
DIN sampling rate:		20 Hz
DIN common wire:		COM9, COM10
TIN common wire:		TINCOM
Communication		
DALI		
Output interface:		DALI
DALI addresses (max.):		16
Internal DALI source:		yes, max. 64 mA
BUS		
Installation bus:		BUS
Indication of unit status:		Green LED RUN
Power		
Internal DALI supply terminals:		terminals COM8 and N
Internal DALI supply voltage:		100-240V 50/60Hz max.0.1A
Power dissipation:		3 W
Connection		
Terminal plate:		max. 2.5 mm ² /1.5 mm ² with core

* adjacent COM terminals (COM1 and 2, COM3 and 4, COM5 and 6, COM7 and 8) must be at the same potential

** input function is set during configuration

*** ACOM and COM9 terminals are at BUS potential

To provide power to the Dali bus via DA+ and DA-, it is essential to establish a 230V connection between Com8 and N.

- The RC3-610M/DALI is an I/O actuator equipped with 6 binary inputs, of which 2 can be configured as temperature inputs and 8 independent relays with switching potential-free and potential contacts. It also includes two analog outputs 0(1)-10 V with a load capacity of up to 10 mA.
- Binary inputs RC3-610M/DALI are used for connecting up to 6 devices with a non-decimal contact (such as switches, switches, buttons of other designu, EZS and EPS detectors and others).
- Temperature inputs support the connection of TC/TZ temperature sensors in a 2-wire connection for temprature sensing needs.
- The actuator is designed for switching up to eight different appliances and loads by relay output (potential-free contact).
- The maximum load capacity of the relay contacts is 10 A/2500 VA/ AC1. Each of the output contacts is individually controllable. Relays are divided into four pairs, where each pair switches on its common potential.
- The DALI system BUS allows control of up to 16 independent DALI (Digital Addressable Lighting Interface) ballast addresses for fluorescent, LED and other luminaires.
- Analog outputs are considered for use with thermoregulation heads, air-conditioning ventilation flaps, various other dimmers or other devices with an analog control voltage of 0-10 V or 1-10 V.
- The parameters of all configurable inputs and outputs are set in the iNELS Designer & Manager configuration software environment, which is designed for Windows 7, 8 and 10 operating systems.
- RC3-610M/DALI in 6-MODULE version is designed for mounting into a switchboard on DIN rail EN60715.

Operating conditions	
Working temperature:	-20 to +55 °C
Storage temperature:	-30 to +70 °C
Degree of protection:	IP20 device, IP40 with cover in the control cabinet
Surge category:	II.
Degree of pollution:	2
Working position:	any
Installation:	to the control cabinet for DIN rail EN 60715
Design:	6-MODULE
Dimensions and weight	
Dimensions:	90 x 105 x 65 mm
Weight:	310 g

Connection

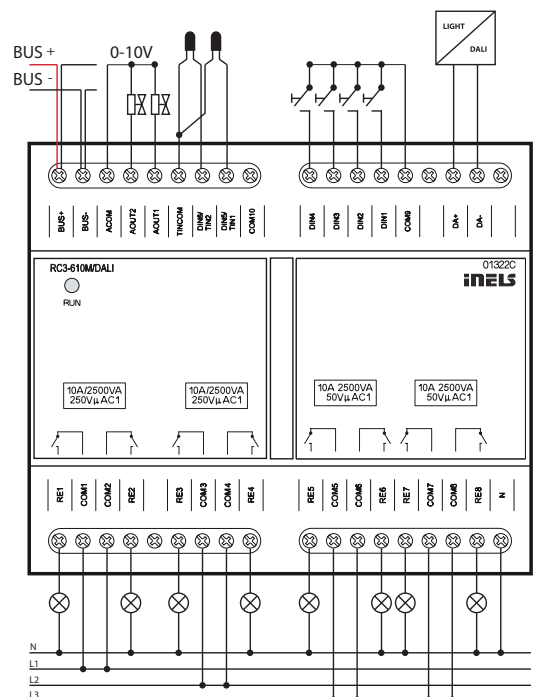

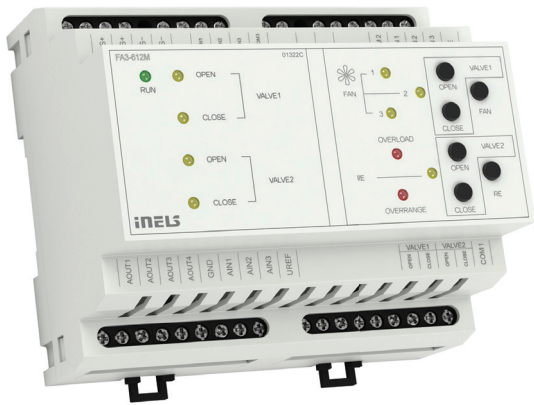

EAN code
FA3-612M: 8595188135276

Technical parameters **FA3-612M**

Input	
Analog inputs:	3x voltage, current or temperature input
Number of inputs:	3
Galv. separation from inner circuits:	no
Diagnostic:	indication red LED OVERRANGE (exceeding the range, interruption of a sensor or overload of Uref output)
Common terminal:	GND
Converter resolution:	14 bits
Input resistance	
- for voltage ranges:	approx. 150 kΩ
- for current ranges:	100 Ω
Types of inputs/measuring ranges*:	Voltage (U): 0 ÷ +10 V (U) ; 0 ÷ +2 V (U) Current (I): 0 ÷ +20 mA (I) ; 4 ÷ +20 mA (I) temperature: input at ext. temperature sensor TC, TZ, Ni1000**, Pt1000**, Pt100** see accessories/ according to used sensor from -30 °C to 250 °C
Digital inputs:	3x switching or expansion, positive logic (SINK)
Input voltage:	20 - 240 V AC (50 - 60 Hz)/DC
Galv. separation from internal circuits:	yes
Common lead:	GO COM3
Outputs	
Analog:	4x (A_OUT1 - A_OUT4)
Voltage analog. output/max. Current:	4x 0(1) - 10 V/10 mA
Uref reference voltage outputs	
Voltage/Current Uref:	10 V DC/100 mA
Output overload indication:	red LED OVERLOAD
SSR (Electronic Relay):	4x (VALVE1 - VALVE2)
Switching voltage:	20 - 240 V AC
Switching capacity:	480 VA
Peak current:	20 A, t ≤ 16 ms
Output indication:	yellow LED
Relay 6A:	4x (FAN1-FAN3, RE)
Switching voltage:	250 V AC, 24 V DC
Switching capacity:	1500 VA/AC1; 300 VA/AC15; 180 W/DC, AC3
Relay outputs separated from all internal circuits:	reinforced insulation (Cat. II surges by EN 60664-1)
Minimum switching load:	500 mW (12 V/10 mA)
Mechanical life:	10x10 ⁶
Electrical life AC1:	6x10 ⁴
Output indication:	yellow LED
Communication	
Installation BUS:	BUS
Status indication unit:	green LED RUN
Power supply	
Supply voltage/tolerance/ rated current:	27 V DC, -20/+10 %, 5 mA
Supply voltage of power section (relay) tolerance/ nominal current:	AC 230 V (50 Hz), -15/+10 %, 20 mA
Dissipated power:	max. 1 W

- FA3-612M is a unit (actuator) designed to control fan coil units using analogue/digital inputs and analog/relay outputs.
- Analog inputs for temperature, voltage or current measurement (Uref reference voltage can also be used).
- The digital inputs are galvanically isolated with positive logic (Sink) in the 24-230 V AC/DC voltage range.
- Analog outputs 0-10 V.
- Connection to the installation BUS.
- Buttons for closing/opening the valve, fan and heating relay.
- The LEDs on the front panel indicate FAN, RE, VALVE1, VALVE2, OVERRANGE, and OVERLOAD status.
- FA3-612M in 6-MODULE version is designed for mounting into a switch-board, on DIN rail EN60715.

Connection	
Terminal:	max. 2.5 mm ² /1.5 mm ² with sleeve
Operating conditions	
Operating temperature:	-20 to +55 °C
Storing temperature:	-30 to +70 °C
Protection degree:	IP20 device, IP40 mounting in the switchboard
Overvoltage category:	II.
Pollution degree:	2
Operating position:	any
Installation:	switchboard on DIN rail EN 60715
Design:	6-MODULE
Dimensions and weight	
Dimensions:	90 x 105 x 65 mm
Weight:	307 g

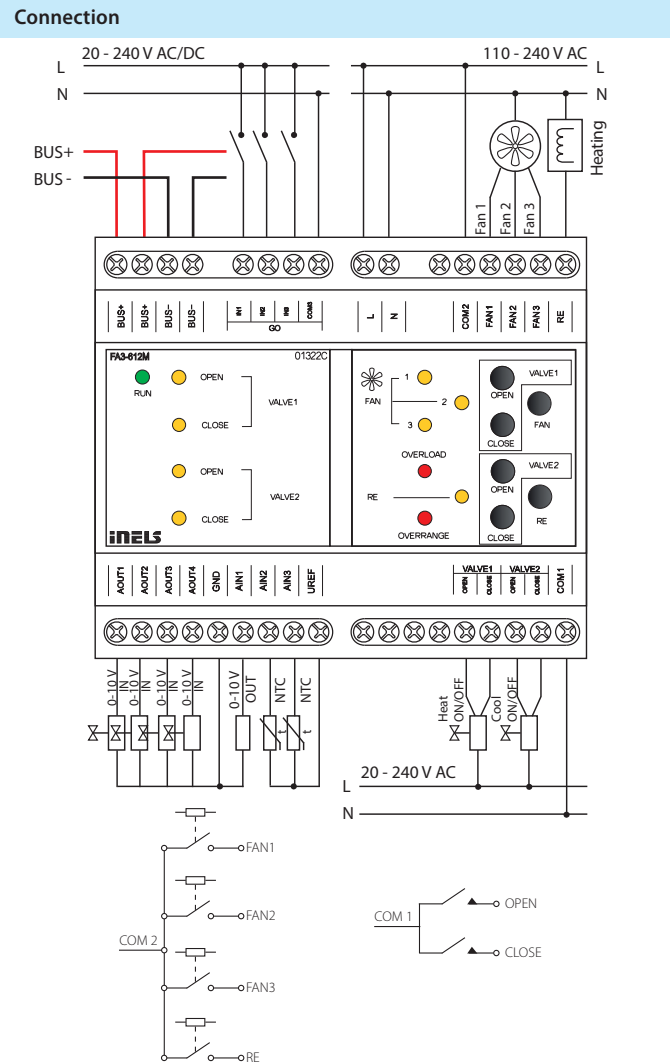

* selectable for each input individually by configuration in the user program IDM3.
** The FA3-612M / Pt version is available for these sensors.

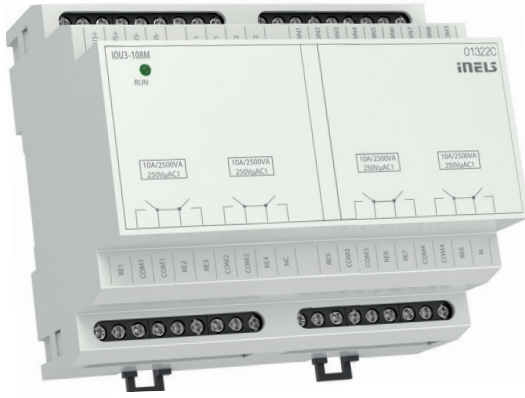

EAN code
IOU3-108M: 8595188181884

Technical parameters		IOU3-108M
Outputs		
Output:	8x switching 8 A/AC1	
Switched voltage:	250 V AC1, 150 W/DC	
Switched output:	2500 VA/AC1, 150 W/DC	
Peak current:	10 A	
Output relays separated from all internal circuits:	reinforced insulation (Cat. II surges by EN 60664-1)	
Isolation between relay outputs COM1, COM2 and COM3:	basic insulation (Cat. II surges by EN 60664-1)	
Isolates. voltage open relay contact:	1 kV	
Max. current of one common terminal:	16 A	
Minimal switched current:	100 mA/10 V DC	
Switching frequency without load:	300 min ⁻¹	
Switching frequency with rated load:	15 min ⁻¹	
Mechanical life:	10 000 000	
Electrical life AC1:	100 000	
Mains voltage detection:	yes - (relay switched to neutral)	
Inputs		
Input:	8x NO or NC against GND (-)	
Max. frequency pulse reading:	20 Hz	
Temperature input for temperature measuring:	2x input for external thermo sensor TC, TZ (NTC 12k)	
Temperature measurement range:	by type of sensor, prob from -40 °C to 125 °C	
Converter resolution:	15 bit	
Communication		
Installation BUS:	BUS	
Status indication unit:	green LED RUN	
Power supply		
Voltage of BUS/tolerance/nominal current:	27 V DC, -20/+10 %, 110 mA	
Dissipated power:	3 W	
Connection		
Terminal:	max. 2.5 mm ² /1.5 mm ² with sleeve	
Operating conditions		
Operating temperature:	-20 to +55 °C	
Storing temperature:	-30 to +70 °C	
Protection degree:	IP20 device, IP40 mounting in the switchboard	
Overvoltage category:	II.	
Pollution degree:	2	
Operating position:	any	
Installation:	switchboard on DIN rail EN 60715	
Design:	6-MODULE	
Dimensions and weight		
Dimensions:	90 x 105 x 65 mm	
Weight:	310 g	

- IOU3-108M is combined actuator equipped with 8 binary inputs, 2 temperature inputs and 8 independent relays with switching potential-free contacts.
- Binary inputs IOU3-108M are used to connect up to 8 devices with a potential-free contact (such as switches, buttons, burglar alarm and fire detectors or others).
- The unit can be used to read pulses from energy meters with a pulse output.
- The temperature inputs support the connection of the following temperature sensors: TC / TZ - 2-wire connection.
- They are used in cases where it is necessary to measure the temperature, eg floor/space, indoor/outdoor temperature, technological equipment - boiler rooms, solar heating, etc.
- The maximum load capacity of the contacts is 10 A / 2500 VA / AC1.
- Each of the output is individually controllable and addressable.
- The relays are divided into four pairs, where each pair switches its common potential.
- The actuator is designed for switching up to eight different appliances and loads via a relay output (potential-free contact).
- IOU3-108M in 6-MODULE design is designed for mounting in a switch-board on DIN rail EN60715.

Connection

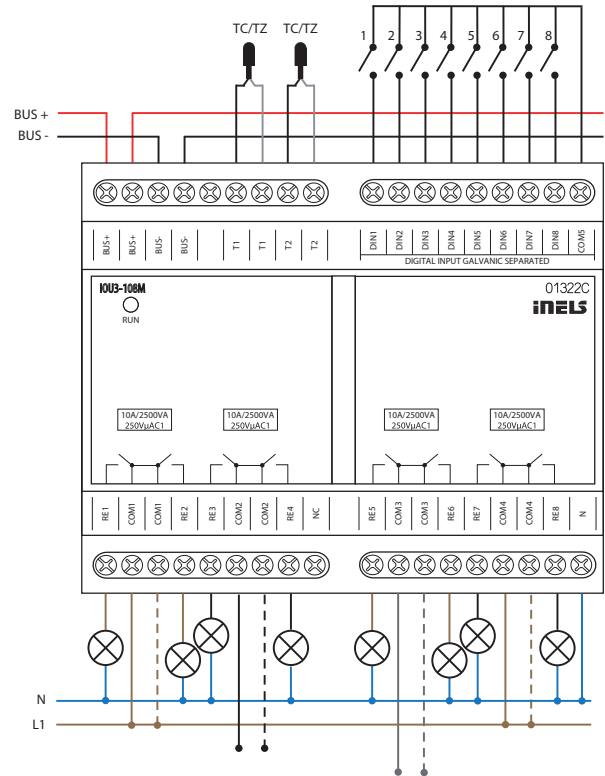

Diagram

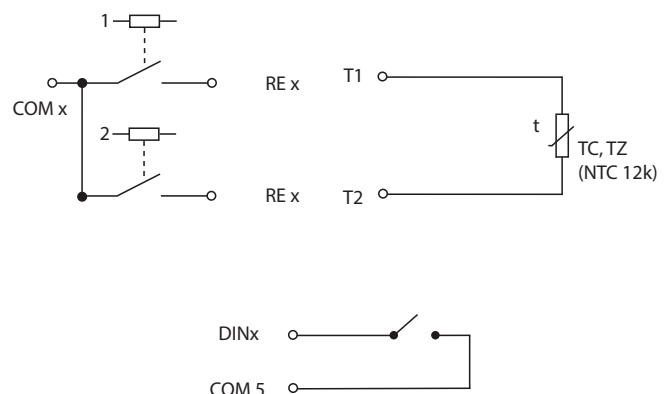

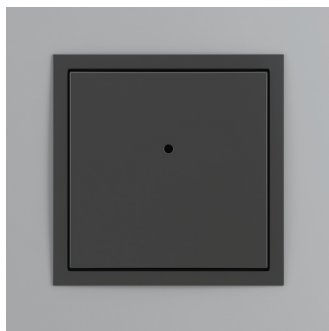

EAN code
 WSB3-20: 8595188132343
 WSB3-20H: 8595188132473

Technical parameters	WSB3-20	WSB3-20H
Inputs		
Temperature measuring:	yes, built-in temperature sensor	
Scope and accuracy of temp. measuring:	0 to +55 °C ; 0.3 °C from the range	
Number of control buttons:	2	
Humidity measurement:	NO	YES
Humidity measurement range:	-	0 to 99 % Relative humidity
Humidity measurement accuracy:	-	± 3 % Relative humidity
Inputs:	2x AIN/DIN	
External temperature sensor:	YES, the connection between AIN1/DIN1 and AIN2/DIN2	
Type of ext. sensor:	TC/TZ	
Temperature measurement range:	-20 °C to +120 °C	
Temp. measurement accuracy:	0.5 °C from range	
Outputs		
Indication:	two-colored LED (red, green)	
Number of LEDs:	1	
Communication		
Installation BUS:	BUS	
Power supply		
Supply voltage/tolerance:	27 V DC, -20/+10 %	
Dissipated power:	max. 0.5 W	
Rated current:	25 mA (at 27 V DC), from BUS	
Connection		
Terminals:	0.5 - 1 mm ²	
Operating conditions		
Operating temperature:	-20 to +55 °C	
Storing temperature:	-30 to +70 °C	
Protection degree:	IP20	
Overvoltage category:	II.	
Pollution degree:	2	
Operation position:	any	
Installation:	into installation box	
Dimensions and weight		
Dimensions		
- plastic:	85.6 x 85.6 x 42 mm	
- metal, glass, wood, granite:	94 x 94 x 36 mm	
Weight:	55 g (without frame)	

- Wall controllers with low-upstroke control WSB3-20 and WSB3-20H are the main and most frequently used units (controller) in the iNELS system.
- Built-in micro-buttons with low upstroke offer elegant and easy controlling.
- Wall switches WSB3-20 and WSB3-20H are available in 2-channels version.
- Double color (red/green) LED diode indicates either status of controlled appliances or status of any sensor or actuator in the system.
- Wall buttons in WSB3 series are compatible with both types of frames LOGUS⁹⁰ (85.6 x 85.6 or 94 x 94 mm), therefore you can combine them with double and triple frames and classic products of the series.
- Each controller is equipped with a temperature sensor. It is also equipped with two analog/digital inputs (AIN/DIN), which can be used to connect two potentialless contacts or one external temperature sensor TC/TZ (e.g. for measuring floor temperature).
- Wall button WSB3-20H is comparable to the WSB3-20 but additionally equipped with a relative humidity meter, and for better access of air to the sensor can be used with 99621T including accessories 99622 (Vista MT) and 99623 (Vista IRMT), instead of the housing cover 99601T.
- Compared to standard wall buttons WSB3-20 and WSB3-20H are more flexible and multifunctional. You can for example controll appliances by short and long push of the button (e.g.: dimming, shutter control, scenes).
- Each button can control any appliance in the system and can use a variety of centralized or time controlled features. Accordingly, the customer can choose the simplicity/complexity of the operation. The big advantage is the possibility to change the method of control by only making software modifications without physical interventions into the structure of the building.
- Each button (fold) can have different functional modes beside lighting control:
 - a) Classic wall-switch:
 - upper button ON, bottom button OFF
 - b) Button controller (impulse relay):
 - first press ON, second press OFF
 - c) Dimmer:
 - short press – ON/OFF
 - d) Time switch:
 - ON after press, automatically OFF after set time
 - e) Setting light scenes – for example: for watching TV:
 - shutters down
 - main light 30% intensity
 - wall-lamps 50% intensity
- WSB3 in LOGUS⁹⁰ design is designed for mounting into an installation box.

Connection

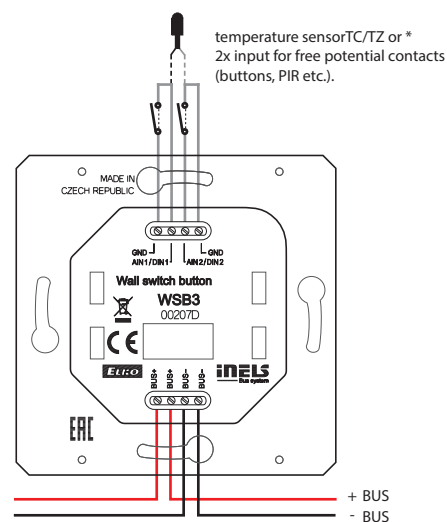

* The choice is made in iDM3 for each unit separately.

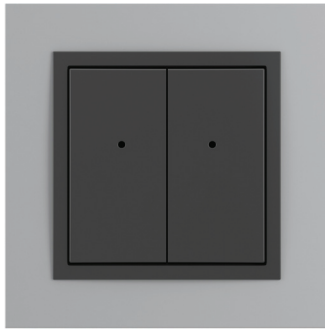

EAN code
 WSB3-40: 8595188132336
 WSB3-40H: 8595188133043

Technical parameters	WSB3-40	WSB3-40H
Inputs		
Temperature measuring:	YES, built-in temperature sensor	
Scope and accuracy of temp. measuring:	0 to +55 °C ; 0.3 °C from the range	
Number of control buttons:	4	
Humidity measurement:	NO	YES
Humidity measurement range:	-	0 to 99 % Relative humidity
Humidity measurement accuracy:	-	± 3 % Relative humidity
Inputs:	2x AIN/DIN	
External temperature sensor:	YES, the connection between AIN1/DIN1 and AIN2/DIN2	
Type of external sensor:	TC/TZ	
Temp. measurement range:	-20 °C to +120 °C	
Temp. measurement accuracy:	0.5 °C from range	
Outputs		
Indication:	two-colored LED (red, green)	
Number of LEDs:	2	
Communication		
Installation BUS:	BUS	
Power supply		
Supply voltage/tolerance:	27 V DC, -20/+10 %	
Dissipated power:	max. 0.5 W	
Rated current:	25 mA (at 27 V DC), from BUS	
Connection		
Terminals:	0.5 - 1 mm ²	
Operating conditions		
Operating temperature:	-20 to +55 °C	
Storing temperature:	-30 to +70 °C	
Protection degree:	IP20	
Overvoltage category:	II.	
Pollution degree:	2	
Operation position:	any	
Installation:	into installation box	
Dimensions and weight		
Dimensions		
- plastic:	85.6 x 85.6 x 42 mm	
- metal, glass, wood, granite:	94 x 94 x 36 mm	
Weight:	55 g (without frame)	

* The choice is made in iDM3 for each unit separately.

- Wall mounted controllers with upstroke control WSB3-40 and WSB3-40H are the basic and most popular feature (control) of the iNELS system.
- Built-in micro-switch with low upstroke offers elegant and pleasant control.
- Controllers WSB3-40 and WSB3-40H are supplied with 4-channels.
- Two-coloured indication LEDs located in each controller, can signal the status of controlled appliances or the status of any sensor or actuator in the system.
- Wall buttons in WSB3 series are compatible with both types of frames LOGUS⁹⁰ (85.6x85.6 or 94x94 mm), therefore you can combine them with double and triple frames and classic products of the series.
- Each controller is equipped with a temperature sensor. It is also equipped with two analog/digital inputs (AIN/DIN), which can be used to connect two potentialless contacts or one external temperature sensor TC/TZ (e.g. for measuring floor temperature).
- Compared to standard wall buttons WSB3-20 and WSB3-20H are more flexible and multifunctional. You can for example controll appliances by short and long push of the button (e.g.: dimming, shutter control, scenes).
- Each button can control any appliance in the system and can use a variety of centralized or time controlled features. Accordingly, the customer can choose the simplicity/complexity of the operation. The big advantage is the possibility to change the method of control by only making software modifications without physical interventions into the structure of the building.
- Each button (fold) can have different functional modes beside lighting control:
 - a) Classic wall-switch:
 - upper button ON, bottom button OFF
 - b) Button controller (impulse relay):
 - first press ON, second press OFF
 - c) Dimmer:
 - short press – ON/OFF
 - d) Time switch:
 - ON after press, automatically OFF after set time
 - e) Setting light scenes – for example: for watching TV:
 - shutters down
 - main light 30% intensity
 - wall-lamps 50% intensity
- WSB3 in LOGUS⁹⁰ design is designed for mounting into an installation box.

Connection

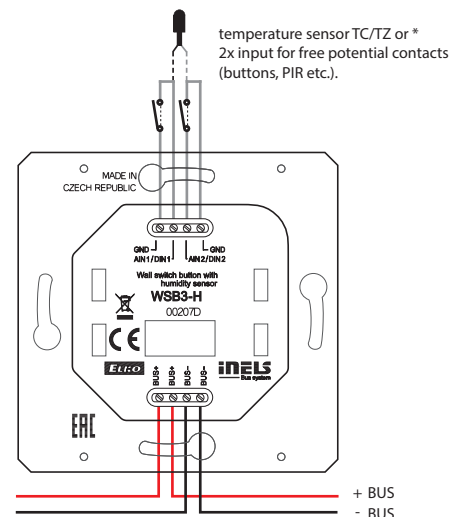

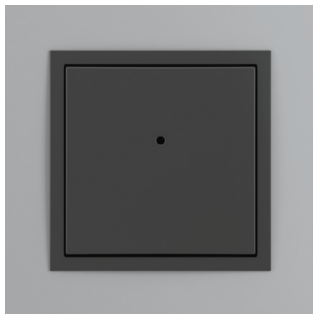

EAN code
WMR3-21: 8595188132756

Technical parameters WMR3-21

Inputs

Number of control buttons:	2
----------------------------	---

RFID readers

Supported frequencies:	13.56 MHz
Card Type:	MIFARE Ultralight, DESFire 2K (EV1), DESFire 4K (EV1)

Outputs

Output:	1x changeover 8 A/AgSnO ₂
Indication:	two-color LED (red, green)
Acoustic output:	piezo-changer
Switching voltage:	230 V A/30 V DC
Switching output:	2000 VA/AC1; 240 W/DC
Peak current:	20 A/<3s
Insulation voltage between relay outputs and internal circuits:	3.75 kV, SELV according to EN 60950
Minimal switched current:	10 mA/10 V
Switching frequency without load:	300 min ⁻¹
Switching frequency with rated load:	15 min ⁻¹
Mechanical life:	1x 10 ⁷
Electrical life AC1:	1x 10 ⁵

Communication

Installation BUS:	BUS
-------------------	-----

Power supply

Supply voltage/tolerance:	27 V DC, -20/+10 %
Dissipated power:	max. 0.5 W
Rated current:	50 mA (at 27 V DC), from BUS

Connection

Data:	terminals, 0,5 - 1 mm ²
Network:	max. 2.5 mm ² /1.5 mm ² with sleeve

Operating conditions

Operating temperature:	-20 to +55 °C
Storing temperature:	-30 to +70 °C
Protection degree:	IP20
Overvoltage category:	II.
Pollution degree:	2
Operation position:	any
Installation:	into installation box

Dimensions and weight

Dimensions	
- plastic:	85.6 x 85.6 x 42 mm
- metal, glass, wood, granite:	94 x 94 x 36 mm
Weight:	68 g (without frame)

- WMR3-21 is a wall-mounted card reader that is designed to read contactless media (smart cards, key chains, etc.), which are used for controlling access to buildings or their parts.
- With the glass controller WMR3-21 users will appreciate the ease of control using two push buttons, which can be assigned different control functions: lighting, shading, scenes, heating, etc.
- WMR3-21 reader can be used to control the security system (locking/unlocking) access system (opening doors, gates, etc.) or appliances (based on assigned rights).
- WMR3-21 supports RFID media with the carrier frequency of 13.56 MHz. Supported card types: MIFARE Ultralight, DESFire 2K (EV1), DESFire 4K (EV1).
- WMR3-21 is also equipped with 8 A relay output with changeover contact AgSnO₂, by which controlled devices can be switched directly (or any actuator in the system can be set in software iDM3).
- Indication two-color LED in the controller cover can indicate not only the status of the controlled appliance, but also the status of any sensor or actuator in the system.
- Wall card reader WMR3-21 is compatible with both types of frames LOGUS⁹⁰ (85.6 x 85.6 or 94 x 94 mm), therefore you can combine them with double and triple frames and classic products of the series.

Connection

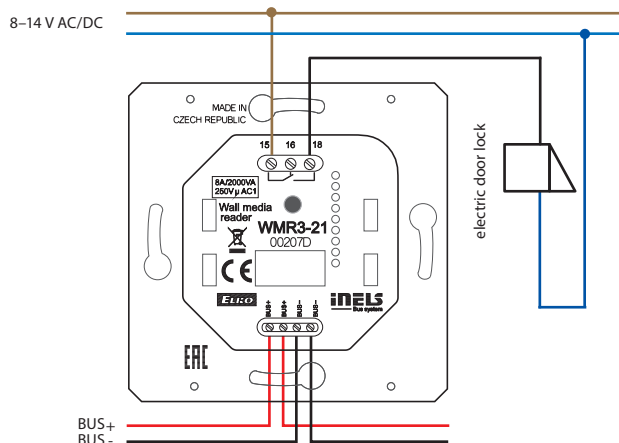

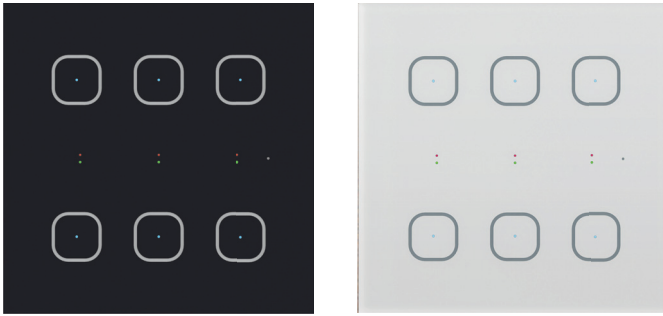

EAN code
 GMR3-61/B: 8595188155854
 GMR3-61/W: 8595188155793

Technical parameters **GMR3-61**

Inputs	
Temperature measuring:	YES, built-in temperature sensor
Scope and accuracy of temp. measuring:	0 to +55°C; 0.3°C from the range
Number of control buttons:	6

RFID readers	
Supported frequencies:	13.56 MHz
Card Type:	MIFARE Ultralight, DESFire 2K (EV1), DESFire 4K (EV1)

Outputs	
Indication:	3 pairs of LED (red, green)
Output:	1x changeover 8 A/AgSnO ₂
Acoustic output:	piezo-changer
Switching voltage:	230 V AC/30 V DC
Switching output:	2000 VA/AC1; 240 W/DC
Peak current:	20 A/<3s
Insulation voltage between relay outputs and internal circuits:	3.75 kV, SELV according to EN 60950
Minimal switched current:	10 mA/10 V
Switching frequency without load:	300 min ⁻¹
Switching frequency with rated load:	15 min ⁻¹
Mechanical life:	1x 10 ⁷
Electrical life AC1:	1x 10 ⁵

Communication	
Installation BUS:	BUS

Power supply	
Supply voltage/tolerance:	27 V DC, -20/+10 %
Dissipated power:	max. 2 W
Rated current:	50 mA (at 27 V DC), from BUS

Connection	
Data:	terminals, 0.5 - 1 mm ²
Network:	max. 2.5 mm ² /1.5 mm ² with sleeve

Operating conditions	
Relative humidity:	max. 80 %
Operating temperature:	-20 to +55 °C
Storing temperature:	-30 to +70 °C
Protection degree:	IP20
Overvoltage category:	II.
Pollution degree:	2
Operation position:	any
Installation:	into installation box

Dimensions and weight	
Dimensions:	94 x 94 x 36 mm
Weight:	155 g

- Wall RFID card reader GMR3-61 is designed for reading of contactless media (chip cards, key fobs, tags, etc.), which are used for controlling access to buildings or parts of buildings.
- With the glass controller GMR3-61 users will appreciate the elegant design and the easy of control using six touch buttons, which can be assigned different control functions lighting, shading, scenes, heating, etc.
- GMR3-61 a design element of the (control) system iNELS and is available in black (GMR3-61/B) and white (GMR3-61/W) variants.
- GMR3-61 reader can be used to control the security system (locking/unlocking) access system (opening doors, gates, etc.) or appliances (based on assigned rights).
- GMR3-61 supports RFID media with the carrier frequency of 13.56 MHz. Supported card types MIFARE Ultralight, DESFire 2K (EV1), DESFire 4K (EV1).
- The GMR3-61 is also equipped with 8 A relay output with changeover contact AgSnO₂, which can be switched directly by reader (or by any controller in the system).
- Between each pair of touch keys is a pair of indicator LEDs (Green, Red) to indicate the status of the controlled appliance, or the state of any sensor or actuator in the system.
- Located on each touch button is a blue LED indicator, signalling the touch of a button. Touching may also be signalled by a vibrating pulse or audible tone - optionally in the software iDM3.
- All variants of GMR3-61 are available in sizes of luxury controllers LOGUS⁹⁰ (94 x 94 mm).
- GMR3-61 reader is equipped with a sensor of ambient light intensity. Based on information from the sensor can switch the orientation of blue LEDs on the touch-pad GSB3 or perform various actions with the software iDM3, eg. To control the lighting circuits in the corridor and others.
- GMR3-61 cannot be installed into multiple frames they are designed for mounting into installation boxes.

Connection

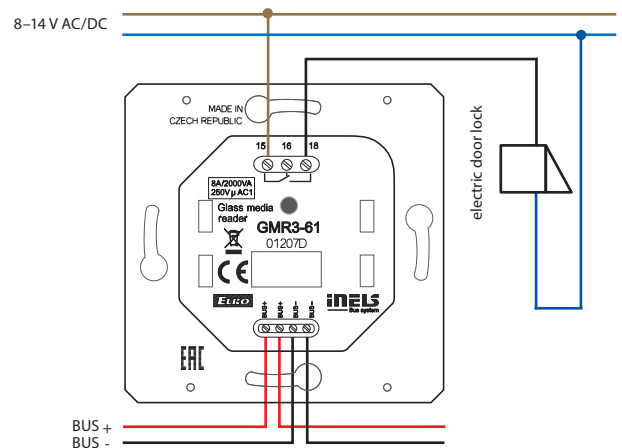



EAN code

GSB3-240/W: 8595188189576	GSB3-260/W: 8595188189590	GSB3-90/B_V2: 8595188188272	GSB3-60/W_V2: 8595188132985
GSB3-240/B: 8595188189569	GSB3-290/B: 8595188189606	GSB3-90/W_V2: 8595188188289	GSB3-40/B_V2: 8595188132909
GSB3-260/B: 8595188189583	GSB3-290/W: 8595188189613	GSB3-60/B_V2: 8595188132916	GSB3-40/W_V2: 8595188132954

Technical parameters GSB3-40|240 GSB3-60|260 GSB3-90|290

Inputs

Temperature measuring:	YES, built-in temperature sensor
Scope and accuracy of temp. measurement:	0 to +55 °C; 0.3 °C from the range
Humidity measurement:	YES
Humidity measurement range:	0 to 99 % RH
Inputs:	AIN/DIN
Resolution:	by setting 10-bit
External temperature sensor:	YES, the connection between AIN1/DIN1 and AIN2/DIN2
Type of external sensor:	TC/TZ
Temperature measurement range:	-20 °C to +120 °C
Temperature measurement accuracy:	0.5 °C from the range

Buttons

Number of control buttons:	4	6	9
Type:	capacitive		
Indication:	white highlighted point		

Outputs

Acoustic output:	piezo-changer
------------------	---------------

Communication

Installation BUS:	BUS
-------------------	-----

Power supply

Supply voltage/tolerance:	27 V DC, -20/+10 %		
Dissipated power:	max. 0.5 W		
Rated current:	20-38 mA	20-45 mA	20-50 mA
	(at 27 V DC), from BUS		

Connection

Terminals:	EIB \varnothing 0.6 - 0.8 mm ²
------------	---

Operating conditions

Relative humidity:	max. 80 %
Operating temperature:	-20 to +55 °C
Storing temperature:	-30 to +70 °C
Protection degree:	IP20
Overvoltage category:	II.
Pollution degree:	2
Operation position:	any
Installation:	on the wall, observing the conditions for correct installation of the sensor

Dimensions and weight

Dimensions:	94 x 94 x 41 mm 100 x 100 x 8 mm
Weight:	154 g

- Glass touch controllers GSB3-XXX are part of a comprehensive range of glass iNELS control units and can be advantageously used in all projects for example as a part of guest room management system (GRMS).
- The GSB3-40, GSB3-60, and GSB3-90 models feature a square design, while the GSB3-240, GSB3-260, and GSB3-290 models come in a round design.
- GSB3-40, GSB3-240 is equipped with four, GSB3-60, GSB3-260 six and GSB3-90, GSB3-290 nine touch buttons whose functions can easily modify by the software.
- The glass touch controllers is equipped with an integrated temperature sensor. It is also equipped with analog-to-digital input (AIN/DIN), which can be used to connect potential-free contact or external temperature sensor TC/TZ (for example temperature measurement of the floor).
- Advantages over conventional switches/buttons are saving space, signaling the state of any system output, the ability to measure temperature as well as the ability to connect external buttons or detectors.
- Each button can control any actuator (appliance) in the system. Also, you can assign each button a different function or macro (set of functions). It is therefore possible to use one button to control several appliances at once.
- Glass touch panel is a design component of the iNELS system and is available in elegant black (GSB3-XXX/B) and white (GSB3-XXX/W) versions.
- The individual capacitive buttons are point-illuminated by a white LED indicating the status of the controlled output.
- All versions are in the size of the standard module (94x94 mm) and designed for mounting into an installation box.

Other variants

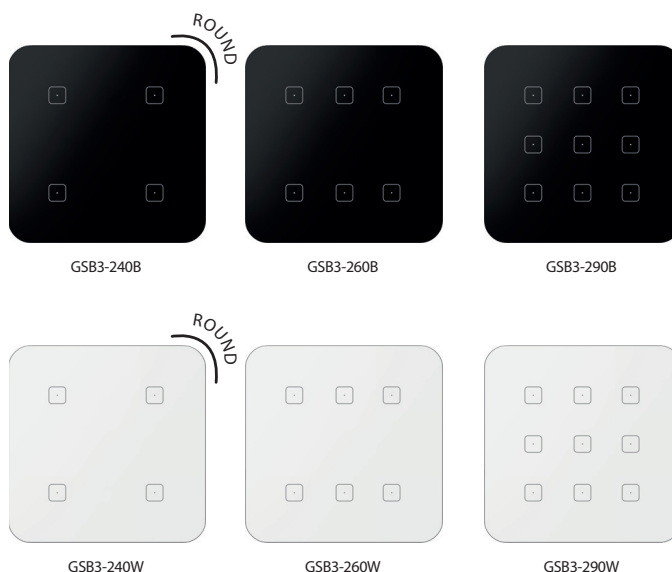

GSB3-240W

GSB3-260W

GSB3-290W

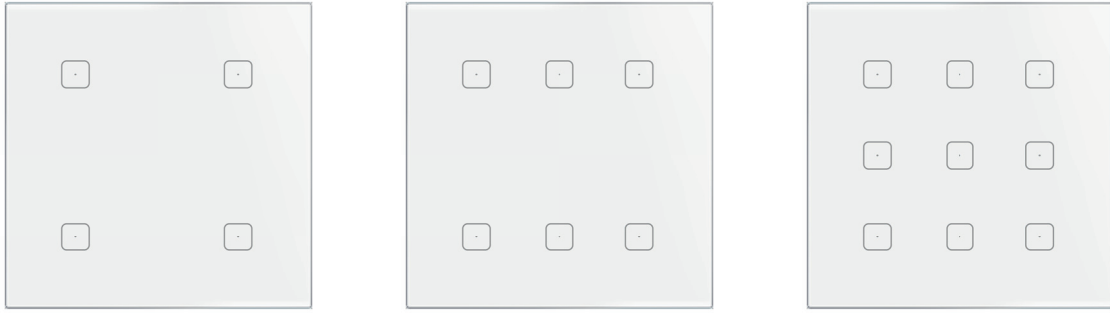

Connection

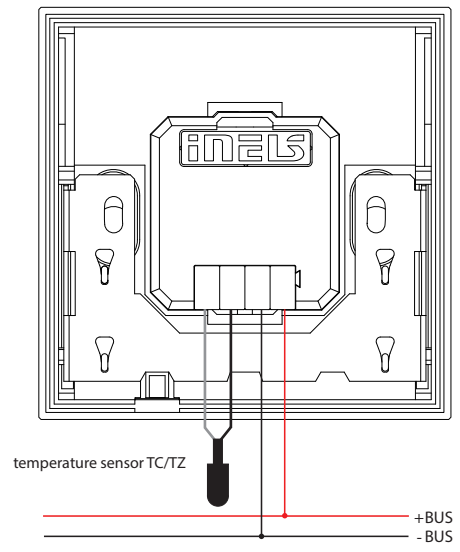
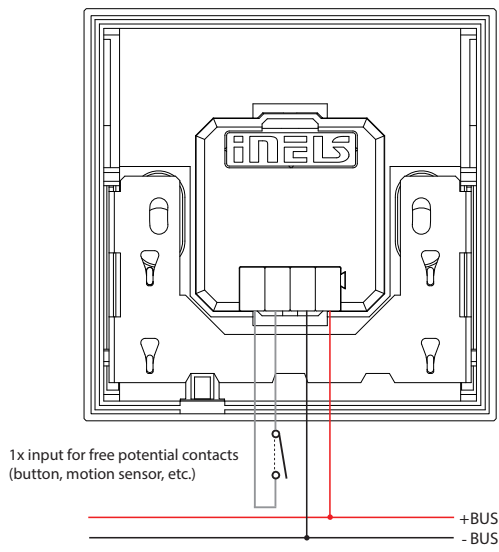

Another view



GSB3-60B



GSB3-260W



The picture of device is illustrative, the icons (symbols) are configurable by the customer.

EAN code
 GSB3-40/SB_V2: 8595188156233 GSB3-40/SBP_V2: 8595188188883 GSB3-60/SWP_V2: 8595188188876 GSB3-90/SW_V2: 8595188188265 GSB3-240/SBP: 8595188189682 GSB3-240/SW: 8595188189637 GSB3-260/SWP: 8595188189712 GSB3-290/SB: 8595188189668
 GSB3-40/SW_V2: 8595188156240 GSB3-60/SB_V2: 8595188156257 GSB3-60/SBP_V2: 8595188188869 GSB3-90/SBP_V2: 8595188188845 GSB3-240/SB: 8595188189620 GSB3-260/SBP: 8595188189705 GSB3-260/SW: 8595188189651 GSB3-290/SWP: 8595188189736
 GSB3-40/SWP_V2: 8595188188890 GSB3-60/SW_V2: 8595188156264 GSB3-90/SB_V2: 8595188188258 GSB3-90/SWP_V2: 8595188188852 GSB3-240/SWP: 8595188189699 GSB3-260/SB: 8595188189644 GSB3-290/SBP: 8595188189729 GSB3-290/SW: 8595188189675

Technical parameters GSB3-40/S|240/S GSB3-60/S|260/S GSB3-90/S|290/S

Inputs

Temperature measuring:	YES, built-in temperature sensor
Scope and accuracy of temp. measurement:	0 to +55 °C; 0.3 °C from the range
Humidity measurement:	YES
Humidity measurement range:	0 to 99 % RH
Inputs:	AIN/DIN
Resolution:	by setting 10-bit
External temperature sensor:	YES, the connection between AIN1/DIN1 and AIN2/DIN2
Type of external sensor:	TC/TZ
Temperature measurement range:	-20 °C to +120 °C
Temperature measurement accuracy:	0.5 °C from the range
Illuminance sensor:	1 to 100 000 Lx
Proximity Sensor:	motion detection at a distance of 0.25 m

Buttons

Number of control buttons:	4	6	9
Type:	capacitive		
Indication:	coloured illuminated symbol		

Outputs

Acoustic output:	piezo-changer
------------------	---------------

Communication

Installation BUS:	BUS
-------------------	-----

Power supply

Supply voltage/tolerance:	27 V DC, -20/+10 %		
Dissipated power:	max. 0.5 W		
Rated current:	25-43 mA	25-50 mA	25-50 mA
	(at 27 V DC), from BUS		

Connection

Terminals:	EIB \varnothing 0.6 - 0.8 mm ²
------------	---

Operating conditions

Relative humidity:	max. 80 %
Operating temperature:	-20 to +55 °C
Storing temperature:	-30 to +70 °C
Protection degree:	IP20
Overvoltage category:	II.
Pollution degree:	2
Operation position:	any
Installation:	on the wall, observing the conditions for correct installation of the sensor

Dimensions and weight

Dimensions:	94 x 94 x 41 mm 100 x 100 x 8 mm
Weight:	154 g

- Glass touch controllers with symbols GSB3-XX/S are part of a comprehensive range of glass iNELS control units and can be advantageously used in all projects for example as a part of guest room management system (GRMS).
- The GSB3-40/S, GSB3-60/S, and GSB3-90/S models feature a square design, while the GSB3-240/S, GSB3-260/S, and GSB3-290/S models come in a round design.
- GSB3-40/S, GSB3-240/S is equipped with four, GSB3-60/S, GSB3-260/S six and GSB3-90/S, GSB3-290/S nine touch buttons whose functions can easily modify by the software.
- Engraving of symbols are possible upon a request.
- The glass touch controllers is equipped with an integrated temperature sensor. It is also equipped with analog-to-digital input (AIN/DIN), which can be used to connect potential-free contact or external temperature sensor TC/TZ (for example temperature measurement of the floor).
- Advantages over conventional switches/buttons are saving space, signalling the state of any system output, the ability to measure temperature as well as the ability to connect external buttons or detectors.
- Each button can control any actuator (appliance) in the system. Also, you can assign each button a different function or macro (set of functions). It is therefore possible to use one button to control several appliances at once.
- Glass touch panel is a design component of the iNELS system and is available in elegant black (GSB3-XXX/SB) and white (GSB3-XXX/SW) versions.
- Individual symbols can be illuminated in one of seven colours - red, green, blue, yellow, pink, turquoise and white.
- All versions are in the size of the standard module (94x94 mm) and are designed for mounting into an installation box.
- In addition to all the features in symbol models. The glass touch controllers in the SBP/SWP version are equipped with a proximity sensor, which can light up the symbols by approaching the unit to approx. 0.25 m.
- SWP/SBP models are also equipped with a sensor of ambient light intensity. Based on information from the sensor it can switch backlight of symbols or perform various actions in the iDM3 software, for example also switch the lighting circuits in the room.

Other variants

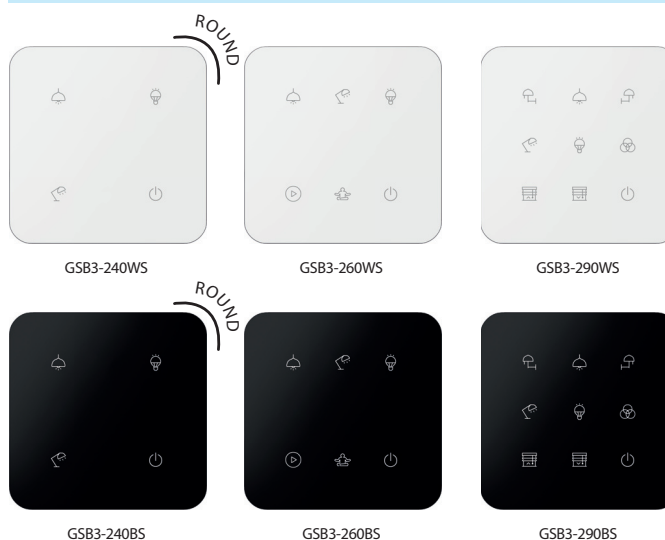

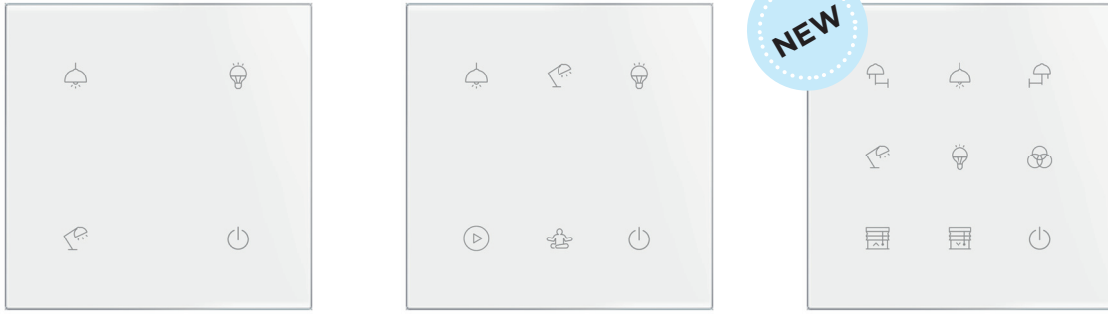

The picture of device is illustrative, the icons (symbols) are configurable by the customer.

Connection

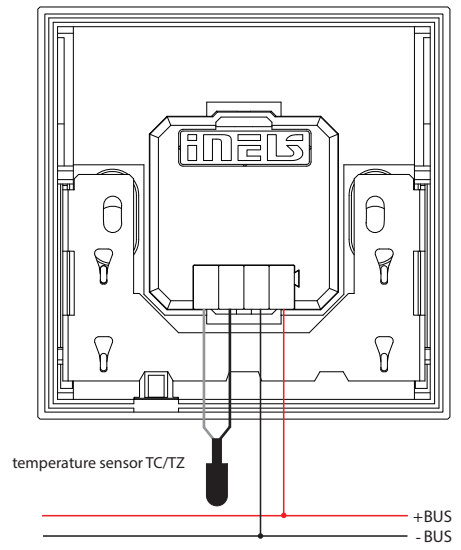
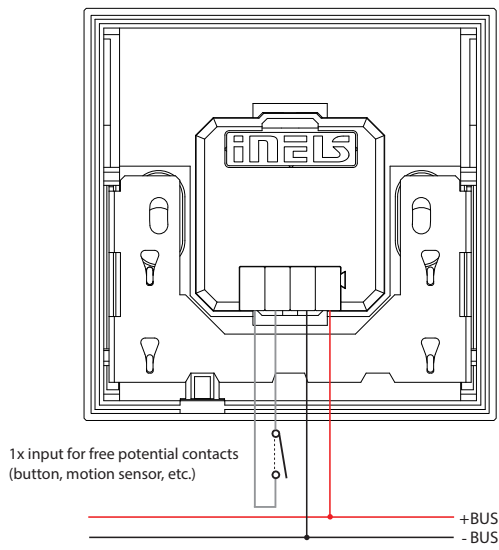

Another view



GSB3-60BS



GSB3-260WS

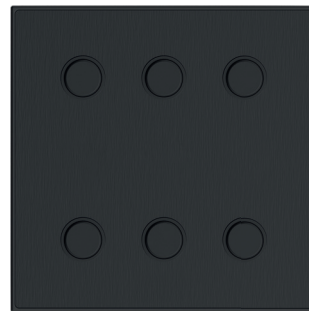
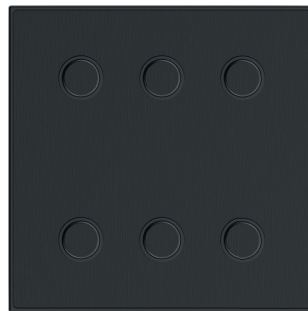
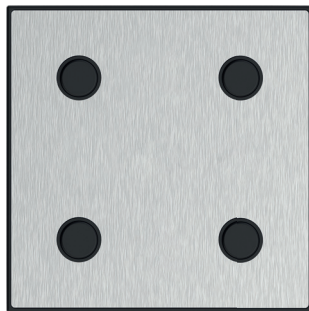
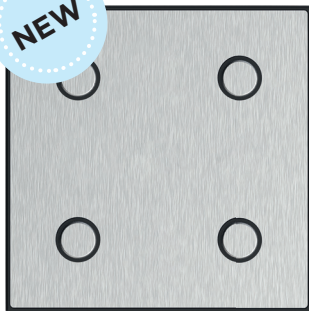

EAN code

MSB3-40SS: 8595188191364
MSB3-40SB: 8595188191371MSB3-40GG: 8595188191388
MSB3-40GB: 8595188191395MSB3-40CC: 8595188191401
MSB3-40CB: 8595188191418MSB3-40BB: 8595188191425
MSB3-60SS: 8595188191449MSB3-60SB: 8595188191456
MSB3-60GG: 8595188191463MSB3-60GB: 8595188191470
MSB3-60CC: 8595188191487MSB3-60CB: 8595188191494
MSB3-60BB: 8595188191500

Technical parameters	MSB3-40	MSB3-60	MSB3-90
Inputs			
Temperature measuring:	YES, built-in temperature sensor		
Scope and accuracy of temp. measurement:	0 to +55 °C; 0.3 °C from the range		
Humidity measurement:	YES		
Humidity measurement range:	0 to 99 % RH		
Inputs:	AIN/DIN		
External temperature sensor:	YES, the connection between AIN1/DIN1 and AIN2/DIN2		
Type of external sensor:	TC/TZ		
Temperature measurement range:	-20 °C to +120 °C		
Temperature measurement accuracy:	0.5 °C from the range		
Illuminance sensor:	1 to 12 000 Lx		
Buttons			
Number of control buttons:	4	6	9
Type:	button		
Indication:	white illuminated button		
Outputs			
Acoustic output:	piezo-changer		
Communication			
Installation BUS:	BUS		
Power supply			
Supply voltage/tolerance:	27 V DC, -20/+10 %		
Dissipated power:	max. 0.5 W		
Rated current:	25-43 mA	25-50 mA	25-50 mA
	(at 27 V DC), from BUS		
Connection			
Terminals:	EIB \varnothing 0.6 - 0.8 mm ²		
Operating conditions			
Relative humidity:	max. 80 %		
Operating temperature:	-20 to +55 °C		
Storing temperature:	-30 to +70 °C		
Protection degree:	IP40		
Overvoltage category:	II.		
Pollution degree:	2		
Operation position:	any		
Installation:	on the wall, observing the conditions for correct installation of the sensor		
Dimensions and weight			
Dimensions:	94 x 94 x 40 mm		

- Metal switch buttons MSB3-40/XX, MSB3-60/XX and MSB3-90/XX are part of a comprehensive range of iNELS control units and can be advantageously used in all projects.
- MSB3 comes with premium metal plates in the antique copper, satin brass, brushed silver, and graphite black finish.
- MSB3-40/XX is equipped with four, MSB3-60/XX six and MSB3-90/XX nine touch buttons whose functions can easily modify by the software.
- The metal switch button are equipped with an integrated temperature sensor. It is also equipped with analog-to-digital input (AIN/DIN), which can be used to connect potential-free contact or external temperature sensor TC/TZ (for example temperature measurement of the floor).
- Advantages over conventional switches/buttons are saving space, signalling the state of any system output, the ability to measure temperature as well as the ability to connect external buttons or detectors.
- Each button can control any actuator (appliance) in the system. Also, you can assign each button a different function or macro (set of functions). It is therefore possible to use one button to control several appliances at once.
- Metal switch button is a design component of the iNELS system and is available in antique copper, satin brass, brushed silver, and graphite black versions.
- Individual buttons can be illuminated in white.
- MSB3-40/XX, MSB3-60/XX and MSB3-90/XX are designed for mounting into an installation box.
- All versions are in the size of the standard module (94x94 mm).

Another view



MSB3-90

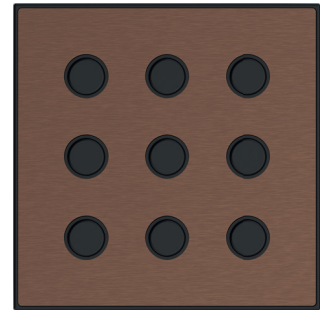
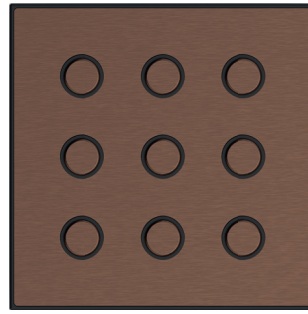
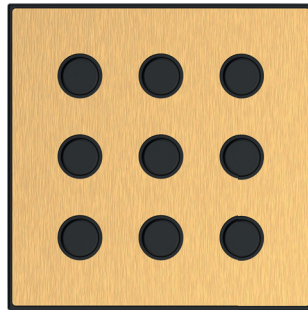
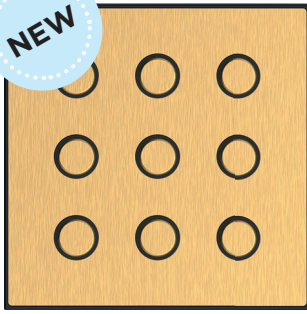

MSB3-90SS: 8595188189460 MSB3-90GG: 8595188189088 MSB3-90CC: 8595188191319 MSB3-90BB: 8595188191333
 MSB3-90SP: 8595188189446 MSB3-90GB: 8595188189453 MSB3-90CB: 8595188191326

Connection

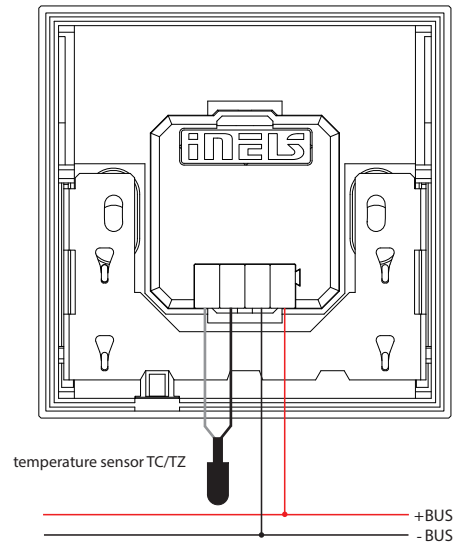
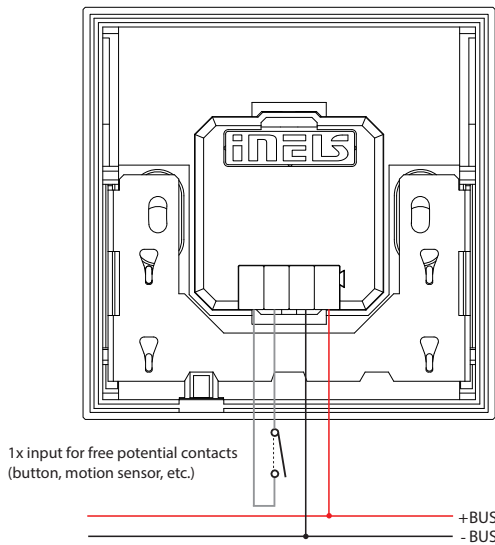

Part number

metal •..... **MSB3-90/xx**• type of button

switch •.....

button •.....

iNELS3 •.....

9 buttons •.....

•.....• color of metal

G - Satin brass plate

B - Graphite black plate

S - Brushed silver plate

C - Antique copper plate

G - Satin brass buttons

B - Black buttons

S - Brushed silver buttons

C - Antique copper buttons

Example

MSB3- XX/BB = Graphite Black plate + Black button
 MSB3- XX/GG = Satin Brass plate + Satin Brass button
 MSB3- XX/GB = Satin Brass plate + Black button
 MSB3- XX/SS = Brushed silver plate + Brushed silver button

MSB3- XX/SB = Brushed silver plate + Black button
 MSB3- XX/CC = Antique copper plate + Antique copper button
 MSB3- XX/CB = Antique copper plate + Black button



EAN code	
IDRT3-1 white:	8595188149488 (device, cover)
IDRT3-1 ivory:	8595188179614 (device, cover)
IDRT3-1 ice:	8595188179591 (device, cover)
IDRT3-1 pearl:	8595188179621 (device, cover)
IDRT3-1 aluminium:	8595188179584 (device, cover)
IDRT3-1 gray:	8595188179607 (device, cover)

Technical parameters

IDRT3-1

Inputs

Temperature measuring:	YES, built-in thermo sensor
Range/accuracy of temp. measuring:	0 to +55 °C; 0.3 °C from range
Heating/cooling circuit correction:	±3, ±4 or ±5 °C
Manual control of heating/cooling circuit:	2 x buttons
External temperature sensor:	YES, the connection between AIN1/DIN1 and AIN2/DIN2
Type of external sensor:	TC/TZ
Temperature measurement range:	-20 °C to +120 °C
Temperature measurement accuracy:	0.5 °C from range

Communication

Installation:	BUS
Display:	symbol display
Backlight:	YES

Power supply

Supply voltage/tolerance:	27 V DC, -20/+10 %
Dissipated power:	max. 0.5 W
Rated current:	20 mA (at 27 V DC), from BUS

Connection

Terminals:	0.5 - 1 mm ²
------------	-------------------------

Operating conditions

Operating temperature:	0 to +50 °C
Protection degree:	IP20
Overvoltage category:	II.
Pollution degree:	2
Operation position:	vertical, downward with BUS terminal
Installation:	into installation box

Dimensions and weight

Dimensions	
- plastic:	85.6 x 85.6 x 50 mm
- metal, glass, wood, granite:	94 x 94 x 50 mm
Weight:	76 g (without frame)

- IDRT3-1 is a digital wall temperature controller used to regulate the temperature in a room.
- Using the IDRT3-1, it is possible to correct the given heating/cooling circuit within a range of ±3, ±4 or ±5 °C (optional in SW iDM3).
- The temperature controller is equipped with an integrated heat sensor used to measure the room temperature. It is also equipped with two analog digital inputs (AIN/DIN), which can be used to connect two potential free contacts or a single external temperature sensor TC/TZ (e.g. for measuring the floor temperature).
- The display shows the current temperature and after pressing one of two buttons under the display, you can control the desired temperature.
- Readability improves after pressing one of the buttons to activate the backlight.
- Heating/cooling circuit is assigned with a thermo-regulator using iDM3.
- In the case of temperature correction within ±3, ±4 or ±5 °C, this change is valid until the next time mark within the time schedule established in iDM3.
- IDRT3-1 in design LOGUS⁹⁰ is intended for mounting into an installation box.

Connection

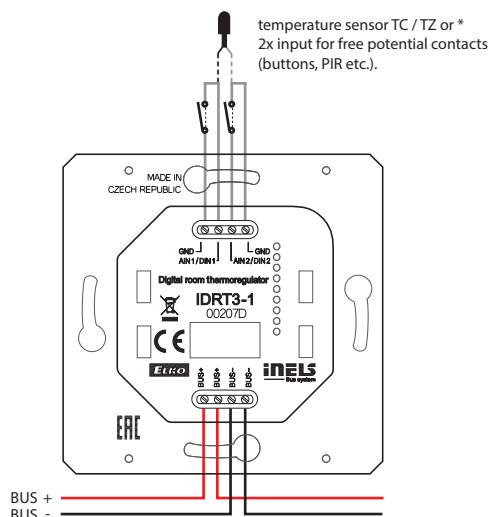

* The choice is made in iDM3 for each unit separately.

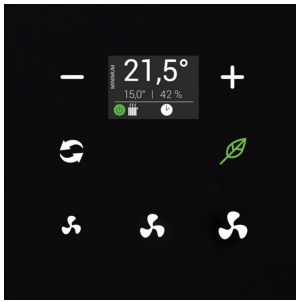

The picture of device is illustrative, the icons (symbols) are configurable by the customer.

EAN code
GRT3-50/B: 8595188156301
GRT3-50/W: 8595188156349

Technical parameters **GRT3-50**

Inputs	
Temperature measuring:	YES, built-in temperature sensor
Scope and accuracy of temp. measurement:	0 to +55 °C; 0.3 °C from the range
Humidity measurement:	YES
Humidity measurement range:	0 to 99 % RH
Humidity measurement accuracy:	± 3 % relative humidity
Inputs:	2x AIN/DIN
Resolution:	by setting 10-bit
External temperature sensor:	YES, the connection between AIN1/DIN1 and AIN2/DIN2
Type of external sensor:	TC/TZ
Temperature measurement range:	-20 °C to +120 °C
Temperature measurement accuracy:	0.5 °C from the range

Buttons	
Number of control buttons:	5
Type:	capacitive
Indication:	coloured illuminated symbol

Display	
Display:	colored TFT, 20 x 25.5 mm
Resolution:	240 x 240 pixels

Outputs	
Acoustic output:	piezo-changer
Tactile output:	vibration motor

Communication	
Installation BUS:	BUS

Power supply	
Supply voltage/tolerance:	27 V DC, -20/+10 %
Dissipated power:	max. 0.5 W
Rated current:	85 mA (at 27 V DC), from BUS

Connection	
Terminals:	0.5 - 1 mm ²

Operating conditions	
Relative humidity:	max. 80 %
Operating temperature:	-20 to +55 °C
Storing temperature:	-30 to +70 °C
Protection degree:	IP20
Overvoltage category:	II.
Pollution degree:	2
Operation position:	any
Installation:	on the wall, observing the conditions for correct installation of the thermostat

Dimensions and weight	
Dimensions:	94 x 94 x 36 mm
Weight:	156 g

- Glass room thermo-regulator GRT3-50 is part of a comprehensive range of glass iNELS control units for guest room management system (GRMS) and serves to regulate the temperature in the room.
- GRT3-50 thermo-regulator has a display for displaying the current room temperature and desired temperature. To adjust the required temperature, it is possible to use the touch buttons with symbols "-" and "+".
- GRT3-50 is also suitable for controlling fan coils and fan speed can be easily adjusted by using the touch buttons with symbols.
- Thermo-regulator GRT3-50 also has a further two touch buttons whose function can be adjusted by software, for example fan coil on/off, heating/cooling or comfort temperature for heating or cooling.
- Thermo-regulator is equipped with an integrated temperature sensor for ambient temperature measurement.
- The glass room thermo-regulator is a design component of the iNELS system and is available in elegant black (GRT3-50/B) and white (GRT3-50/W) version.
- Engraving of symbols is possible upon a request.
- Individual symbols can be illuminated in one of seven colours - red, green, blue, yellow, pink, turquoise and white.
- GRT3-50 are designed for mounting into an installation box.

Connection

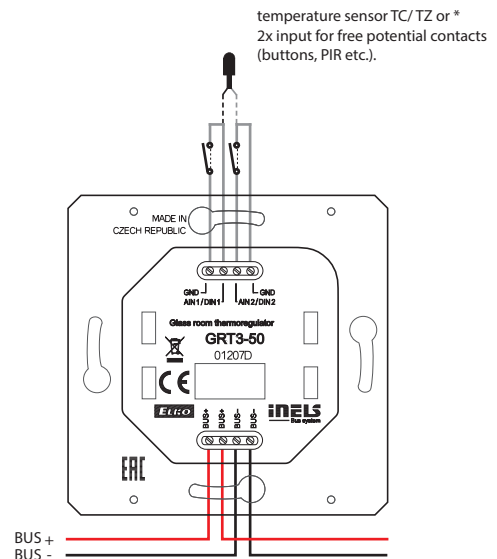

* The choice is made in iDM3 for each unit separately.

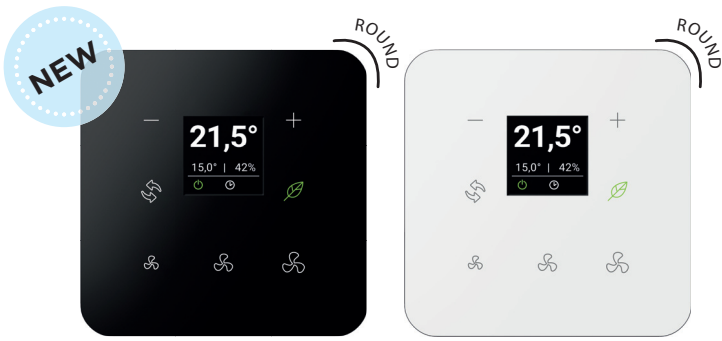

EAN code
 GRT3-70/B: 8595188191548
 GRT3-70/W: 8595188191531
 GRT3-270/B: 8595188191562
 GRT3-270/W: 8595188191555

The picture of device is illustrative, the icons (symbols) are configurable by the customer.

- Glass room thermo-regulator GRT3-70 is part of a comprehensive range of glass iNELS control units for apartments, guest room management system (GRMS) and serves to regulate the temperature in the room.
- GRT3-70 thermo-regulator has a display for displaying the current room temperature and desired temperature. To adjust the required temperature, it is possible to use the touch buttons with symbols "-" and "+".
- GRT3-70 is also suitable for controlling fan coils and fan speed can be easily adjusted by using the touch buttons with symbols.
- Thermo-regulator GRT3-70 also features its touch buttons whose function can be adjusted by software, for example fan coil on/off, heating/cooling or comfort temperature for heating or cooling.
- Thermo-regulator is equipped with an integrated temperature sensor for ambient temperature measurement.
- The glass room thermo-regulator is a design component of the iNELS system and is available in elegant black (GRT3-70/B) and white (GRT3-70/W) version.
- Engraving of symbols is possible upon a request.
- Individual symbols can be illuminated.
- GRT3-70 are designed for mounting into an installation box.

Technical parameters	GRT3-70	GRT3-270
Inputs		
Temperature measuring:	YES, built-in temperature sensor	
Scope and accuracy of temp. measurement:	0 to +55 °C; 0.3 °C from the range	
Humidity measurement:	YES	
Humidity measurement range:	0 to 99 % RH	
Humidity measurement accuracy:	± 3 % relative humidity	
Inputs:	1x AIN/DIN	
Resolution:	by setting 10-bit	
External temperature sensor:	YES, the connection between AIN1/DIN1 and AIN2/DIN2	
Type of external sensor:	TC/TZ	
Temperature measurement range:	-20 °C to +120 °C	
Temperature measurement accuracy:	0.5 °C from the range	
Buttons		
Number of control buttons:	7	
Type:	capacitive	
Indication:	coloured illuminated symbol	
Display		
Display:	colored TFT, 26 x 26 mm	
Resolution:	240 x 240 pixels	
Outputs		
Acoustic output:	piezo-changer	
Communication		
Installation BUS:	BUS	
Power supply		
Supply voltage/tolerance:	27 V DC, -20/+10 %	
Dissipated power:	max. 0.5 W	
Rated current:	85 mA (at 27 V DC), from BUS	
Connection		
Terminals:	0.5 - 1 mm ²	
Operating conditions		
Relative humidity:	max. 80 %	
Operating temperature:	-20 to +55 °C	
Storing temperature:	-30 to +70 °C	
Protection degree:	IP20	
Overvoltage category:	II.	
Pollution degree:	2	
Operation position:	any	
Installation:	on the wall, observing the conditions for correct installation of the thermostat	
Dimensions and weight		
Dimensions:	94 x 94 x 41 mm	
Weight:	156 g	

Other variants

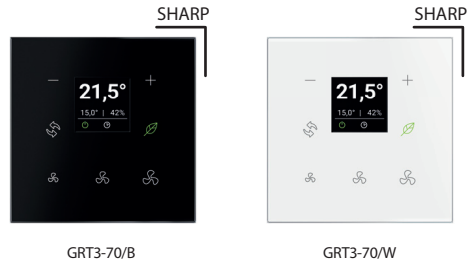

Connection

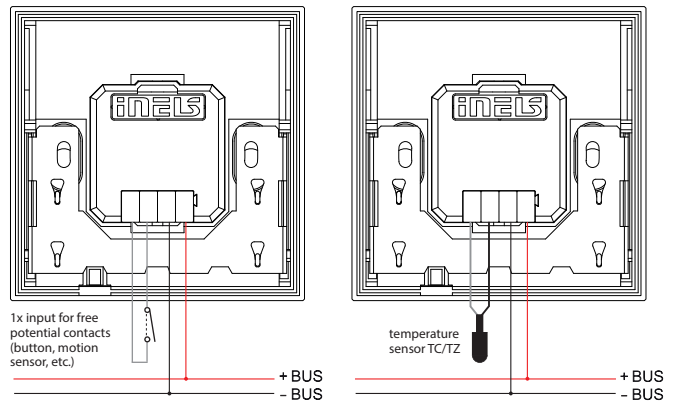

Another view



GRT3-70/W

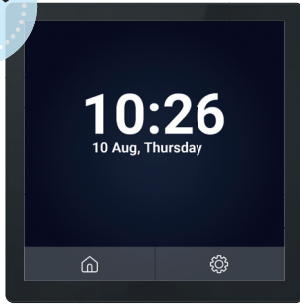

EAN code
 EST4: 8595188199643
 EMF/S 8595188199650
 EMF/G 8595188199667
 EMF/B 8595188199674

Technical parameters		EST4
Hardware / Software		
Hardware	ARM A7 Single-Core 1.2 GHz / 128MB DDR3 Ram / 256 MB Nand flash	
Software:	OS Linux 3.4	
Display		
Type:	IPS 4" 480 x 480 resolution	
Display:	400 cd/m2 luminance	
Touch part:	5 Point capacitive touchscreen	
Power Supply		
Supply voltage/tolerance:	24VDC -or- 48 VDC In	
PoE	POE IEEE 802.3af	
Dissipated power:	Power consumption max. 10W	
Connection		
Standard Interfaces:	(1x) LAN RJ45 10/100Mbps interface (1x) Add-On (optional interface) Port (1x) Digital Out (open collector 5V 100mA) (1x) Digital In	
Optional Interfaces		
	iNELS BUS	
	KNX Twisted Pair (A-KNX)	
	Bticino (SCS) Twisted Pair (A-SCS)	
	RS485 (EIA-485) (RS4)	
	Galvanic isolated RS485 Modbus (A-GMD)	
	VRF mainline communication (A-VRM -or- A-VRR)	
	BLE Bluetooth 5.0 (BCU-S24-BLT -or- BCU-POE-BLT)	
	Zigbee 3.0 (BCU-S24-ZGB -or- BCU-POE-ZGB)	
Built-in Sensors		
Humidity sensor:	range 0% up to 100% RH	
Temperature sensor:	range -40°C up to +125°C	
Operating conditions		
Working temperature:	-10°C – +60°C	
Humidity:	5% – 90% at 25°C	
Dimensions and weight		
Dimensions:	92 x 92 x 29 mm	

- The EST4 offers a feature-rich and versatile solution for control and monitoring applications, with its powerful hardware, user-friendly display, and support for various interfaces and sensors. Its temperature and humidity tolerance make it a reliable choice in different operating environments.
- Featuring a high-quality 4" IPS display with a resolution of 480 x 480 and a luminance of 400 cd/m2, the EST4 offers crisp and clear visuals for an excellent user experience.
- The device runs on Linux 3.4 operating system supporting up to 200 UI objects and 1000 BMS points.
- Equipped with an ARM A7 Single-Core 1.2 GHz processor, 128MB DDR3 RAM, and 256MB Nand flash, ensuring reliable performance for various applications.
- Integrated with essential sensors, the device includes a humidity sensor with a range of 0% up to 100% RH and a temperature sensor covering a range from -40°C up to +125°C, enabling efficient environmental monitoring.
- The EST4 comes with a standard LAN RJ45 10/100Mbps interface, ensuring easy network connectivity for data transfer and communication.
- The EST4 offers a variety of optional interfaces for enhanced connectivity and compatibility. These include RS485, DALI 2, Modbus, VRF, BLE Bluetooth 5.0 and Zigbee 3.0
- The EST4 operates within a working temperature range of -10°C to +60°C.
- The device can be powered by either 24VDC or 48VDC input, and it also supports Power over Ethernet (POE IEEE 802.3af), providing flexibility in power options.
- Configuration, programming and update applications over the Skythings platform.

Connection

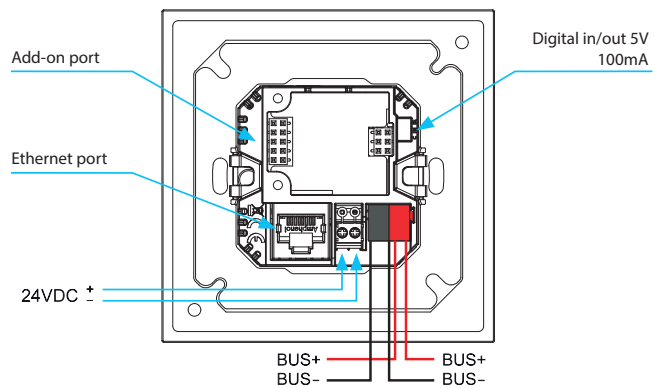

Accessories



● Silver frame ● Gold frame ● Black frame

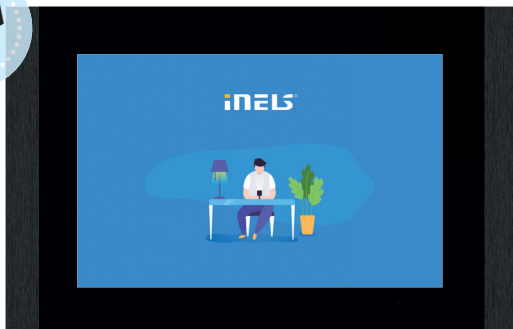

EAN code
iNELS TOUCH iA10: 8595188199636
iNELS TOUCH box: 8595188199681

Technical parameters		iNELS TOUCH iA10
Hardware / Software		
Hardware	Quad-Core 1.2 GHz / 1GB DDR3 Ram / 8GB Nand flash	
Software:	OS Android 7.1 with iNELS application	
Display		
Type:	IPS 10" 1280 x 800 resolution	
Display:	300 cd/m2 luminance	
Touch part:	5 point capacitive touchscreen	
Power Supply:		
Supply voltage/tolerance:	24 VDC	
PoE	PoE IEEE 802.3at (optional w/PSU-TP-POE)	
Dissipated power:	Power consumption max. 13W	
Connection		
Ethernet:	1x LAN RJ45	
Communication speed:	10/100 Mbps interface	
Optional Interfaces		
	iNELS BUS	
	KNX Twisted Pair (A-KNX)	
	Bticino (SCS) Twisted Pair (A-SCS)	
	RS485 (EIA-485) (RS4)	
	Galvanic isolated RS485 Modbus (A-GMD)	
	VRF mainline communication (A-VRM -or- A-VRR)	
	BLE Bluetooth 5.0 (BCU-S24-BLT -or- BCU-POE-BLT)	
	Zigbee 3.0 (BCU-S24-ZGB -or- BCU-POE-ZGB)	
Built-in Sensors		
Humidity sensor:	range 0% up to 100% RH	
Temperature sensor:	range -40°C up-to +125°	
Operating conditions		
Working temperature:	-10°C – +60°C	
Humidity:	5% – 90% at 25°C	
Dimensions and weight		
Dimensions:	307 x 194.6 x 39.5 mm	

- 10" touch panel designed to control iNELS with Android OS. It allows you to install iNELS applications, built-in speakers and a microphone can be used for intercom function.
- 10" touch panel designed to control iNELS units.
- Black aluminum frame chassis in combination with glass.
- Integrated speakers and microphone are primarily designed for intercom operation.
- Connection to the local area network can be done with Ethernet connection with PoE power supply - Active Poe (IEEE 802.3af).
- Android for iNELS applications.
- Update applications over the Internet.
- The panel also includes a cover that also serves as a mounting frame.

Device description

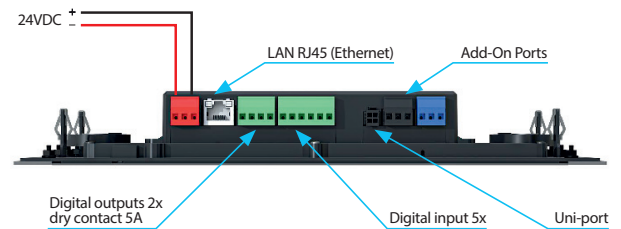

powered by SKY THINGS

powered by INSPIRIA



EAN code
iNELS Bridge 24V DC: 8595188185097

Technical parameters		iNELS Bridge
Communication		
Communication network:	Ethernet	
Pre Installed software:	Connection Server, Home Assistant, Asterisk, MQTT Broker	
Ethernet		
Connectors:	RJ-45	
Communication speed:	10/100Mb	
Ethernet status indication:	LED link	
Preset IP address (ETH):	DHCP, mDNS	
Power supply		
Version 24V DC:	8-36 V DC/1 A	
Operating conditions		
Operating temperature:	-20 to +55 °C	
Storage temperature:	-25 to +70 °C	
Humidity:	max. 80%	
Degree of protection:	IP20	
Overvoltage category:	II.	
Degree of pollution:	2	
Operating position:	any	
Installation:	DIN rail EN 60715	
Design:	1-MODULE	
Terminal:	max. 2.5 mm ²	
Dimensions and weight		
Dimensions:	94 x 17.6 x 64mm	
Weight:	72 g	

- iNELS Bridge works as a gateway for connecting third party devices and integrating them into the iNELS environment.
- It is a one module hardware contain powerful linux based computer.
- The unit comes with an option of pre-installed Connection server, Home assistant with iNELS driver and Asterisk.
- The server uses the open Home Assistant platform, which contains more than 1000 existing integrations.
- The connection server is providing a communication environment between iNELS BUS System with the third-party devices, for which their protocols are also translated and submitted.
- iNELS Bridge is equipped ethernet port for fast and easy communication.
- The configuration is happening on its own web interface, where the default IP address is not fixed. (The IP address is assigned from the DHCP server and it's needed to be known when we're connected to the network).
- The device can be powered by 24VDC input, and it also supports Power over Ethernet (Passive POE), providing flexibility in power options.

Device description

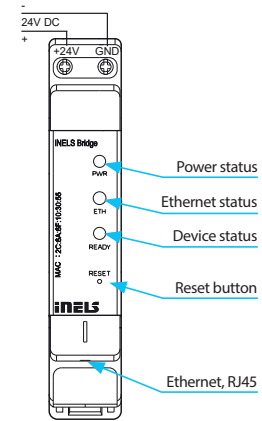

iNELS Bridge 24 V DC

Infrastructure example

iNELS BRIDGE

come with option

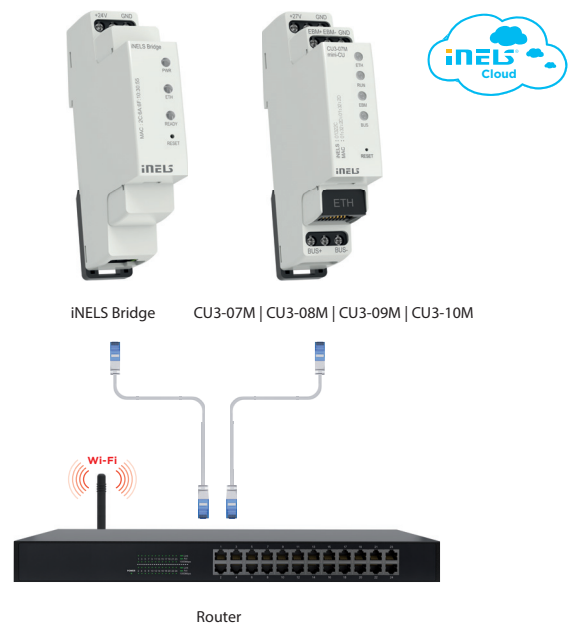



EAN code
Connection server II.: 8595188185080

Technical parameters	Connection Server II
Power:	USB Type-C PD 2.0 with 9V/2A, 12V/2A, 15V/2A, 20V/2A
Video Output:	HDMI
Audio Output:	3.5mm jack with mic
Processor (CPU):	64bits hexa core processor, Dual Cortex-72, frequency 1.8GHz with qual Cortex-A53, frequency 1.4GHz
Memory (SDRAM):	4 GB
Communication Interface:	Gigabit Ethernet, dual-band 802.11ac WiFi 5, Bluetooth 5.0
Connecting peripherals:	2x USB 3.0, 2x USB 2.0
Dimensions:	92,9 x 65 x 50,6 mm (l,w,h)

- The connection server is providing a communication environment between iNELS BUS System with the third party devices, for which their protocols are also translated and submitted.
- The iNELS application's environment enables us to control all these technologies from just one app.
- If the connection server is present in the installation, then it enables option for controlling the installation by application - lighting, blinds, heating, etc., also IP cameras, intercom, air conditioning.
- It also allows the communication with the domestic voice intercom 2N. It can also arrange the information from the weather station Giom or data from energy meters (electricity, water, gas), which is visualized in clear graphs.
- The device connection server uses the Rock Pi hardware and the apps requires a license relative to the MAC address of the device.
- While connecting with the devices connection server, it's recommended to use an uninterruptible power supply (UPS), which ensures that, there will be no power outage.
- The configuration is happening on its own web interface, where the default IP address is not fixed. (The IP address is assigned from the DHCP server and it's needed to be known when we're connected to the network).

Infrastructure example

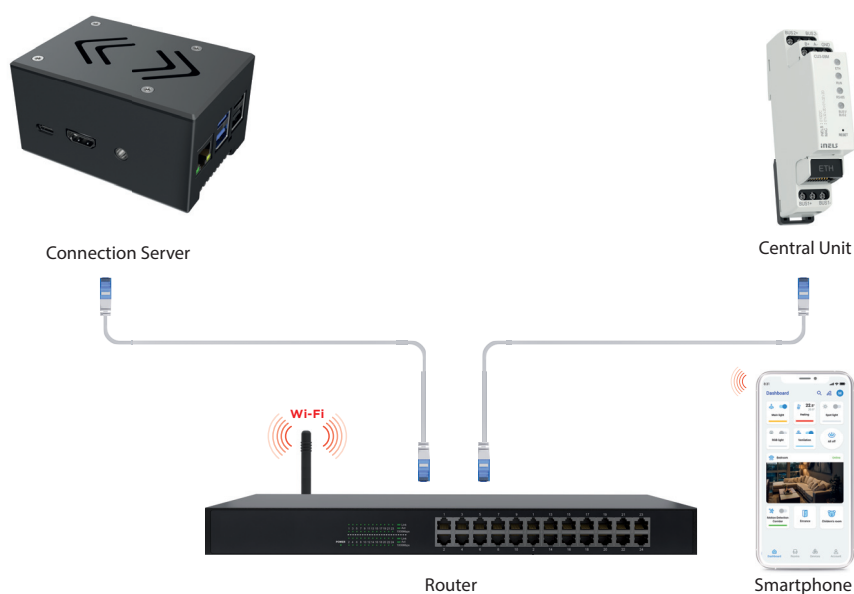

What is MQTT?

(Message Queuing Telemetry Transport)



MQTT (Message Queuing Telemetry Transport) is a communication protocol designed for efficient and reliable data transmission between devices or applications over a network. It was developed for use in situations where messages need to be sent with minimal overhead and low latency, which is crucial in limited or unstable network conditions, such as the Internet of Things (IoT) or mobile networks.

The main features of MQTT

- 1. Publish-Subscribe Model:** MQTT utilizes the "publish-subscribe" model, where clients can publish messages on specific topics, and other clients subscribed to these topics can receive the messages. This model provides a decentralized way of communication and allows a larger number of devices (subscribers) to respond to events from various publishers.
- 2. Low Data Overhead:** The MQTT protocol is designed with efficiency and low data overhead in mind. The message header is very small, reducing bandwidth demands and enabling efficient data transmission even on resource-constrained devices, such as sensors or microcontrollers.
- 3. QoS (Quality of Service):** MQTT allows you to set the level of quality of service for message delivery according to the application's needs. There are three QoS levels:
 - **QoS 0:** It provides "at most once" message delivery, meaning messages may be lost, but they are transmitted with minimal overhead.
 - **QoS 1:** It ensures "at least once" message delivery, but there may be instances of duplicate delivery.
 - **QoS 2:** It guarantees "exactly once" message delivery, which is the most reliable level but requires the most overhead.
- 4. Retained Messages:** MQTT allows the broker to retain the last message on a specific topic. When a new client subscribes to that topic, it immediately receives this retained message. This is useful, for example, in situations where we want to obtain the current state of a device after it connects.
- 5. Easy Connection:** MQTT is designed to make it easy to connect to a broker and start publishing or subscribing to messages. MQTT client implementations are available for various platforms and programming languages, making it easy to integrate them into different applications.
- 6. Broad Support:** MQTT is supported by a wide range of devices and platforms, making it an ideal choice for communication in IoT environments and other applications that require reliable and low-overhead communication.

Thanks to these features, MQTT has become a popular protocol for communication in IoT, sensor networks, telemetry, tracking systems, and other applications where efficient and reliable data transmission over the network is crucial.

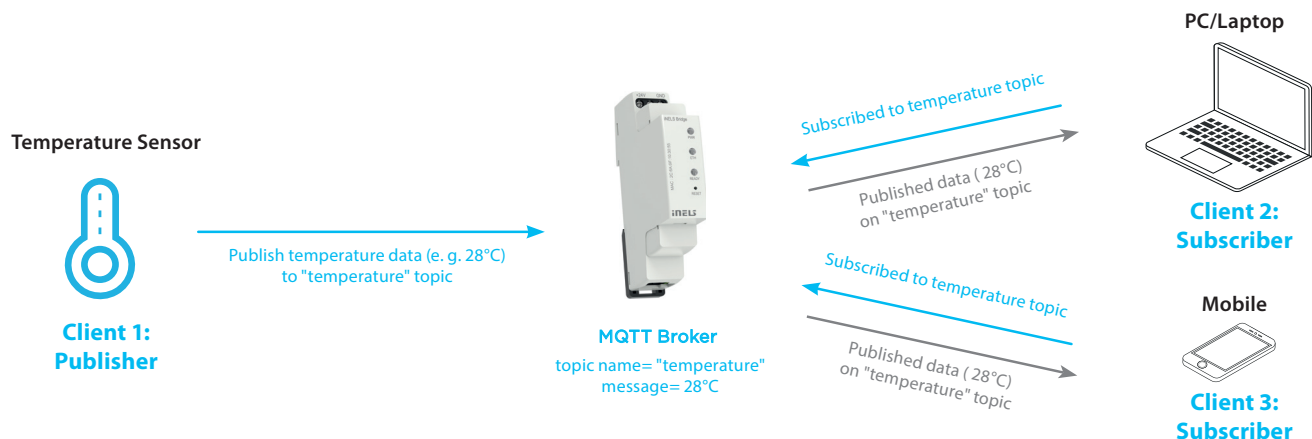

iNELS supports MQTT

The iNELS gateways, both in wired (CU3-07/08M) and wireless (eLAN-RF-103) versions, have implemented bidirectional MQTT communication. In practice, this means that real-time data from all iNELS system components are sent to the MQTT Broker (iNELS Bridge). Additionally, thanks to the bidirectional communication, these components can be freely controlled. This approach makes the iNELS system open for easy integration into superior BMS (Building Management Systems) and PMS (Property Management Systems). It can be easily connected to third-party systems and implemented into various applications.

iNELS Bridge

The revolutionary iNELS Bridge device is unique in that it combines several technologies. Its core feature is the pre-installed MQTT Broker, a software platform that will receive, store, and mediate all MQTT communication within one or even multiple installations.

Home Assistant

Home Assistant is a popular environment for creating and managing all automation systems. In this environment, users or administrators can create their own scenarios or automations across different technologies within the property. An integral part of this is a user-friendly application for mobile platforms or computers.

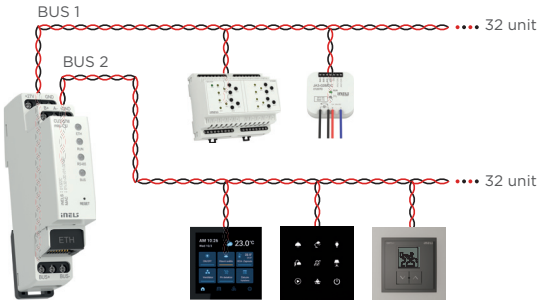

Central unit



INELS Bridge



eLAN Gateway



MQTT Broker

Home Assistant



Cars + chargers

Appliances



Miele
SIEMENS
SONOS
iRobot

... and many others.

WhatsApp
amazon alexa
Google Home
Works with Apple HomeKit



Apps and voice control

Protocols

BACnet
KNX
Modbus
M-Bus
Z-WAVE

protel
FLOWBOX
NETX AUTOMATION
Node-RED
PROMOTIC
Opera
SKY THINGS

Platforms

BMS

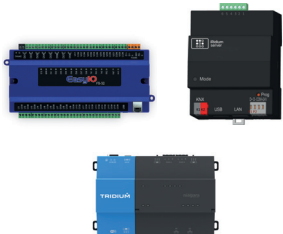

EasyIO[®]
niagara framework[®]
iRidi

Fronius
NIBE



HVAC + photovoltaics

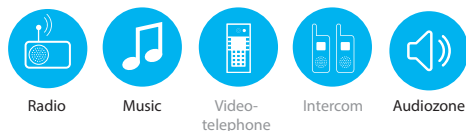

Radio

Music

Video-telephone

Intercom

Audiozone



Technical parameters

LARA Radio

Internet Radio

Supported data transfer formats:	mp3, ogg, acc
----------------------------------	---------------

Control/Settings

Front panel:	touchscreen buttons
Communication Ethernet:	via PC setting up and communicating SW LARA Configurator
Button RESET:	restart product/ reset product to factory settings

Interface ethernet

Communications interface:	10/100 Mbps
Connector:	RJ45
Max. cable length UTP with power:	50 m

Display

Type:	color OLED
Resolution:	128 x 128 pixels
Visible surface:	26 x 26 mm

Power supply

Supply:	Passive PoE 24 V DC/1.25 A
Min. input:	1.4 W
Max. input:	26 W (peak at maximum playback performance)

Amplifier

Amplifier:	stereophonic class D with digital output control
Max. amplifier output:	2 x10 W/8 Ω

Inputs/Outputs

Microphone:	NO
Audio input:	3.5 stereo jack
Audio output 1:	terminals LINE OUT (used for external amplifier)*
Audio output 2:	terminals OUT L/OUT R (speaker output from int. amplifier)

Connection

Terminal block:	0.5 - 1 mm ²
-----------------	-------------------------

Other data

Working temperature:	0 to + 55 °C
Protection degree:	IP20
Overvoltage category:	II.
Pollution degree:	2
Installation:	in an installation box

Dimensions and weight

Dimensions:	
- plastic:	85 x 85 x 46 mm
- metal, glass, wood, granite:	94 x 94 x 46 mm
Weight:	209 g (plastic frame)

* The cable from the LINE OUT terminals must be shielded, max. length should not exceed 5 m.

- A music and internet radio player - all in the dimension of a switch and a luxurious LOGUS⁹⁰ design.
- LARA Radio - when connected to the Internet, it can play streaming radio stations and you can store up to 40 of them. But you can also select from thousands of radio stations from across the globe, which provide data for correct connection.
- LARA Radio can play content from an external music source, which can be a smart phone or e.g. an MP3 player. These devices are connected to a 3.5mm stereo jack audio input, located underneath the front panel.
- Touch control is performed on the device front panel (six capacity buttons available), or LARA Dio.
- The basic device settings (network connection, language, audio input) are performed via the display and a simple menu controlled from capacity buttons on the device front cover. Further settings (selection of stations, connection with the server, updating firmware, etc.) are configured via computer and the software LARA Configurator.
- LARA Radio is equipped with an OLED colored display with the size of 1.5". The display also shows basic information about playing music, which also serves the orientation in the menu settings, etc.
- LARA Radio has an integrated amplifier with 2x 10 W output, thus greatly facilitating device installation in places where such output suffices. LARA is used e.g. to provide premium sound to the kitchen, bathrooms, waiting rooms, offices, reception desks, entrance halls, operating rooms or wellness facilities.
- LARA is powered by PoE with maximum voltage level 27 V DC/ 1000 mA. So connecting and communicating with just one cable (UTP) is a major advantage.
- For LARA, an entire series of accessories is ready for connection (PoE adapters, PoE switches), speakers (in a frame, walls or ceilings) and installation (cables, box, etc.).
- Complies with standards IEEE 802.3u (100BASE-Tx).
- Automatic cable crossing detection of Ethernet cable - MDIX.

EAN code

LARA Radio white:	8595188148719
LARA Radio ivory:	8595188149242
LARA Radio ice:	8595188149228
LARA Radio pearl:	8595188149259
LARA Radio aluminium:	8595188149211
LARA Radio grey:	8595188149235

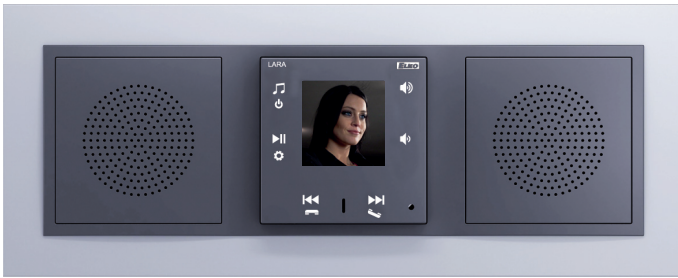
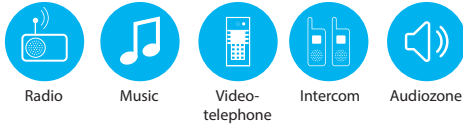

Technical parameters		LARA Intercom
Internet Radio		
Supported data transfer formats:	mp3, ogg, acc	
Control/Settings		
Front panel:	touchscreen buttons	
Communication Ethernet:	via PC setting up and communicating SW LARA Configurator	
Button RESET:	restart product/ reset product to factory settings	
Interface ethernet		
Communications interface:	10/100 Mbps	
Connector:	RJ45	
Max. cable length UTP with power:	50 m	
Display		
Type:	color OLED	
Resolution:	128 x 128 pixels	
Visible surface:	26 x 26 mm	
Power supply		
Supply:	Passive PoE 24 V DC/1.25 A	
Min. input:	1.4 W	
Max. input:	26 W (peak at maximum playback performance)	
Amplifier		
Amplifier:	stereophonic class D with digital output control	
Max. amplifier output:	2 x10 W/8 Ω	
Inputs/Outputs		
Microphone:	YES	
Audio input:	3.5 stereo jack	
Audio output 1:	terminals LINE OUT (used for external amplifier)*	
Audio output 2:	terminals OUT L/OUT R (speaker output from int. amplifier)	
Connection		
Terminal block:	0.5 - 1 mm ²	
Other data		
Working temperature:	0 to + 55 °C	
Protection degree:	IP20	
Overvoltage category:	II.	
Pollution degree:	2	
Installation:	in an installation box	
Dimensions and weight		
Dimensions:		
- plastic:	85 x 85 x 46 mm	
- metal, glass, wood, granite:	94 x 94 x 46 mm	
Weight:	209 g (plastic frame)	

* The cable from the LINE OUT terminals must be shielded, max. length should not exceed 5 m.

- LARA Intercom offers users 5 different functions and expands even more options to Lara Radio - music players and internet radio stations within the range of LOGUS⁹⁰ switch designs.
- LARA Intercom provides an extra functionality and videophone intercom.
- Thanks to videophone function, now it is possible to have a voice communication between LARA and the sound of the door (IP Intercom), so with someone visiting and standing in front of the house, we can see that on LARA display as part of this function which increases the security feeling and safety besides of course, the comfort for the user.
- LARA Intercom is equipped with an OLED colored display with the size of 1.5", which is used to transfer images and sounds from the door camera properly. The display also shows basic information about playing music, which also serves the orientation in the menu settings, etc.
- The intercom function can also be used for communications between all the family members throughout the whole house, thanks to two way voice communications possibilities between different LARA units.
- LARA Intercom continues to offer three functions that are also supported by LARA Radio - when connected to the Internet, it can play streaming radio stations and you can store up to 40 of them. But you can also select from thousands of radio stations from across the globe, which provide data for correct connection.
- LARA Intercom can play content from an external music source, which can be a smart phone or e.g. an MP3 player. These devices are connected to a 3.5mm stereo jack audio input, located underneath the front panel. You can also use LARA for streaming your favorite music from Spotify Premium.
- Touch control is performed on the device front panel (six capacity buttons available), or LARA Dio.
- The basic device settings (network connection, language, audio input) are performed via the display and a simple menu controlled from capacity buttons on the device front cover. Further settings (selection of stations, connection with the server, updating firmware, etc.) are configured via computer and the software LARA Configurator.
- LARA Intercom has an integrated amplifier with 2x 10 W output, thus greatly facilitating device installation in places where such output suffices. LARA is used e.g. to provide premium sound to the kitchen, bathrooms, waiting rooms, offices, reception desks, entrance halls, operating rooms or wellness facilities.
- LARA is powered by PoE with maximum voltage level 27 V DC/ 1000 mA. So connecting and communicating with just one cable (UTP) is a major advantage.
- For LARA, an entire series of accessories is ready for connection (PoE adapters, PoE switches), speakers (in a frame, walls or ceilings) and installation (cables, box, etc.).
- Complies with standards IEEE 802.3u (100BASE-Tx).
- Automatic cable crossing detection of Ethernet cable - MDIX.

EAN code	
LARA Intercom white:	8595188149389
LARA Intercom ivory:	8595188149419
LARA Intercom ice:	8595188149396
LARA Intercom pearl:	8595188149426
LARA Intercom aluminium:	8595188149372
LARA Intercom grey:	8595188149402

Touchscreen operation

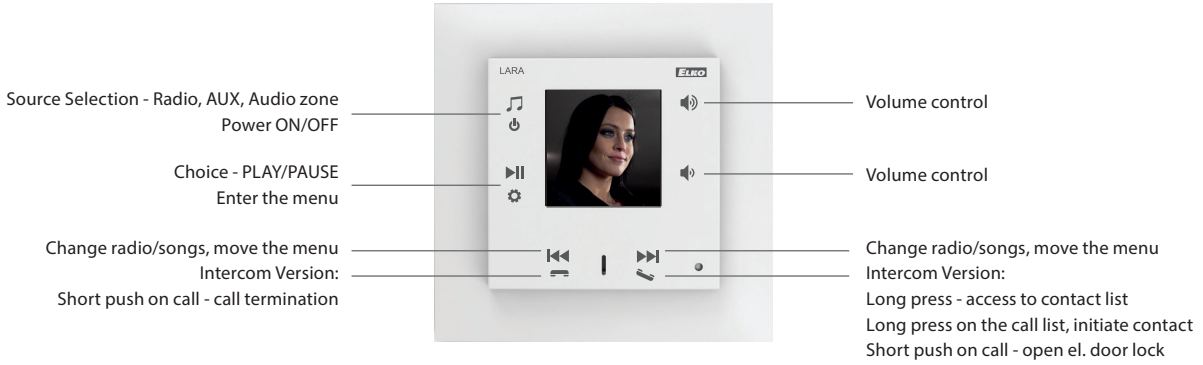

Applications control

Operations, using the application for, LARA Dio and iNELS Home Control for Android and iOS smartphones and tablets.

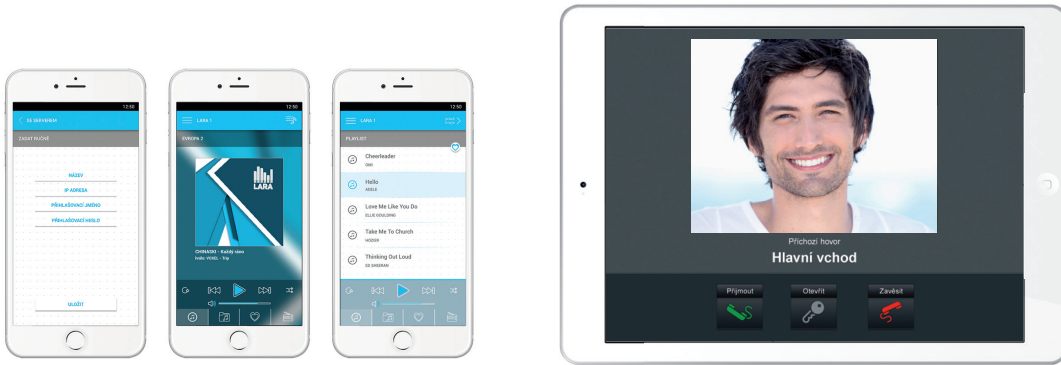

Wiring example

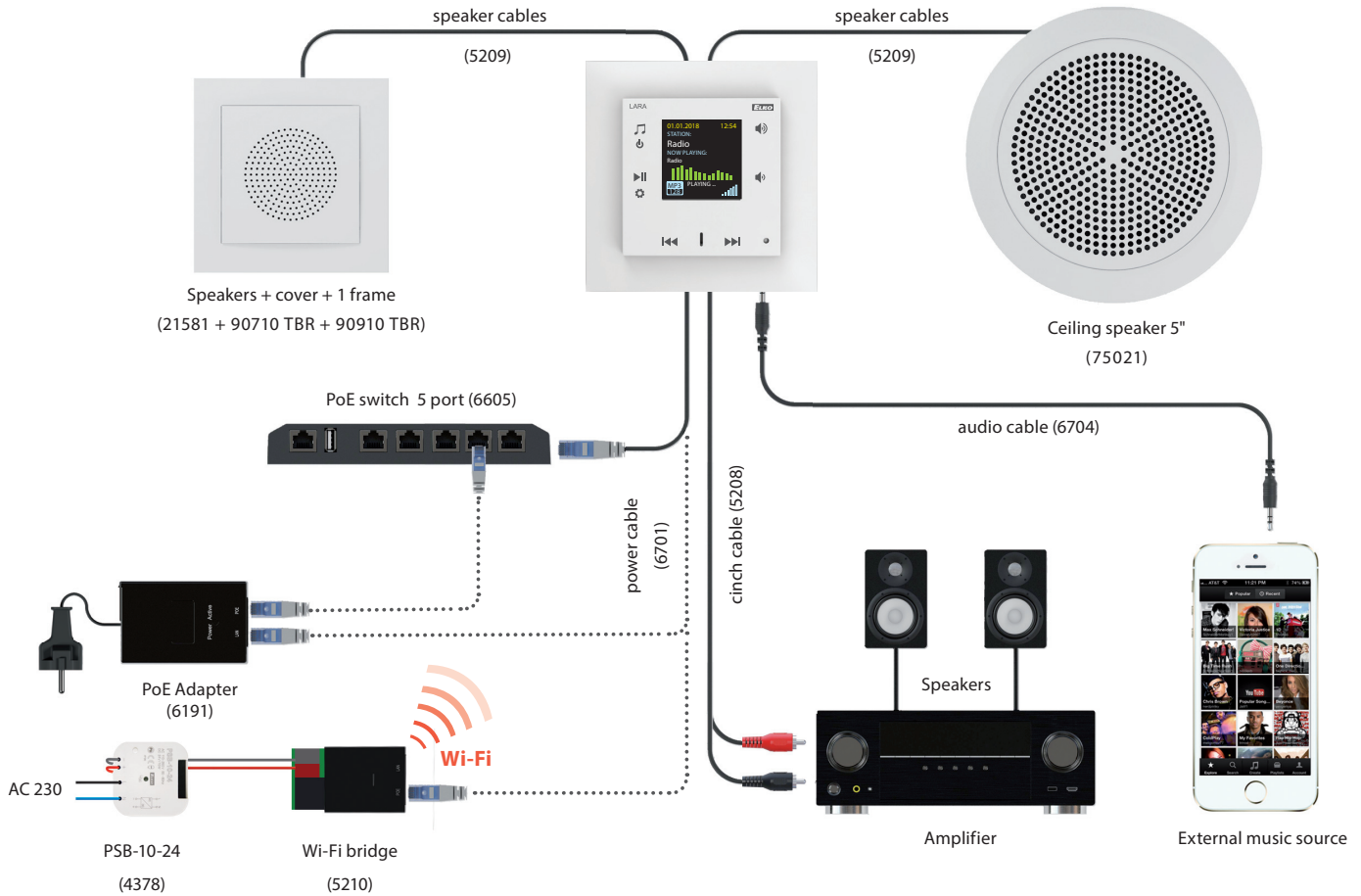

Speakers and cables



AUX CABLE LARA (LARA CINCH CABLE)
Used to connect LARA with exter. amplifier. Reduction 4pin from LARA LINE OUT to 2x CINCH plug into amplifier, length 2 x 20 cm.

5208



POWER SUPPLY (PSB-10-24)
Switching stabilized power supplies with fixed output voltage, intended for mounting into an installation box (e.g. KU-68). PSB-10-24 - stabilized power supply 24V/10 W.

4378



AUX CABLE LARA (LARA AUDIO CABLE)
Used to connect LARA with external music source (smart phone mp3 player). The length is 20 cm terminated with 2x stereo jack 3.5 mm.

6704



CEILING SPEAKER
Speaker is suitable for the installation in suspended ceilings and hollow walls. Mounting hole diameter 143 mm, Power 8 W, 32 Ω speaker impedance.

75021
CBR



SURFACE SPEAKER
Two-way speaker intended for mounting in a ceiling or on the walls: Power 15 W, 32 Ω speaker impedance, dimensions 270x183x37 mm. Color: White

75106
CBR



NETWORK CABLE, 0.2 m
Flat white LAN cable CAT5, length 20 cm, terminated with 2x RJ45 plugs.

6702



NETWORK CABLE, 1 m
Flat white LAN cable CAT5, length 1 m, terminated with 2x RJ45 plugs.

6700

Power supply and network



WI-FI BRIDGE
Used for LARA wireless connection via WiFi network.

5210



PoE SWITCH - 5x RJ45
Provides LAN connectivity and PoE power supply for up to 5 x LARA.

6605



PoE SWITCH - 8x RJ45
Provides LAN and connected PoE of up to 8x LARA. In addition to the 24 V PoE also offers a 48 V PoE for the power supply of 2N.

6606



1-FRAME

90910
TBR



2-FRAME

90920
TBR



3-FRAME

90930
TBR



4-FRAME

90940
TBR



5-FRAME

90950
TBR



SURFACE MOUNT BOX

10976
ABR



INSTALLATION BOX 1 GANG (KP 67/2)

6705



INSTALLATION BOX 2 GANG (KP 64/2)

6706



INSTALLATION BOX 3 GANG (KP 64/3)

6707



INSTALLATION BOX 4 GANG (KP 64/4)

6708



INSTALLATION BOX 5 GANG (KP 64/5)

6709



INSTALLATION BOX 1 GANG (KP 64/LD)

6710



INSTALLATION BOX 2 GANG (KP 64/2L)

6711



INSTALLATION BOX 3 GANG (KP 64/3L)

6712



INSTALLATION BOX 4 GANG (KP 64/4L)

6713



INSTALLATION BOX 5 GANG (KP 64/5L)

6714



UNIVERSAL BOX 1068-02

6716



UNIVERSAL BOX KUH 1/L NA

6717

Power sets



POWER SUPPLY PoE + WiFi INTO OR THE BOX
WiFi bridge with PoE and power supply into an installation box. Power supply 230 V.

5224



POWER SUPPLY PoE INTO A BOX
PoE injector with power supply intended for an installation box. Power supply 230 V.

5226



PoE SUPPLY
Power injector with plug-in adapter 230 V.

5225



POWER SUPPLY PoE + WiFi
WiFi bridge with PoE plug in adapter 230 V.



















5227

The application allows easy control of connected devices through wireless and wired gateways, such as socket switching, dimming lights, controlling blinds or garage doors, managing heating circuits, and compatible air conditioning. It also displays available values, such as temperature, status of motion detectors, windows, doors, or flood detectors, as well as the current status of all controlled devices.

Newly, the application can be installed on tablets, where all control options are fully preserved, just like in the standard application. The user-friendly Dashboard on the tablet enables users to view frequently used devices, previews of connected cameras, and created scenes. Users can quickly and easily control multiple devices at once with a single click. Furthermore, it is now possible to integrate SIP-enabled Intercoms, allowing call notifications and door unlocking from anywhere in the world. Another new feature includes receiving notifications related to units connected to the account. With the new iNELS mobile application, we are opening a completely new stage, expanding the functions and integration possibilities of the iNELS system.

In addition to the iNELS mobile application, there is also the inels.cloud platform available. This website allows users to control devices connected to inels BUS and RF gateways through the cloud. The platform offers advanced features, including the ability to configure custom Dashboards, view historical device data, and conditionally interconnect RF and BUS units. This feature allows users to set conditions to respond to specific events or interconnect devices with each other. Another useful function is push notifications, which inform users about important events or device statuses. With the inels.cloud platform, user management is also possible, enabling account owners to add additional users and restrict their rights to control specific devices.

Thanks to these new updates and features, the iNELS mobile application and inels.cloud platform expand the possibilities and integration options of the iNELS system, providing users with an enhanced and seamless smart home experience.

Electroinstallation		
Wireless	BUS	
		Lighting control •
		Garage doors and gates •
		Switching appliances •
		RGB bulbs and LED strips •
		Scenes •
		Detectors/sensors •
		Heating •
		Air conditioning •
		Recuperation •
		Cameras •
		Weather station •
		Intercoms •
		Home appliances •
		Google Home •
		Amazon Alexa •
		Automation •
		Notification •
		Favourites/overview •
		Log history •
		Weather data •
		Users management •



Conditions

Unlimited automation options.

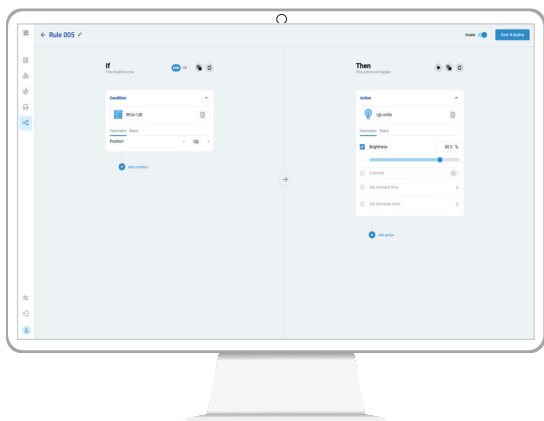

User management

Control of user accounts.

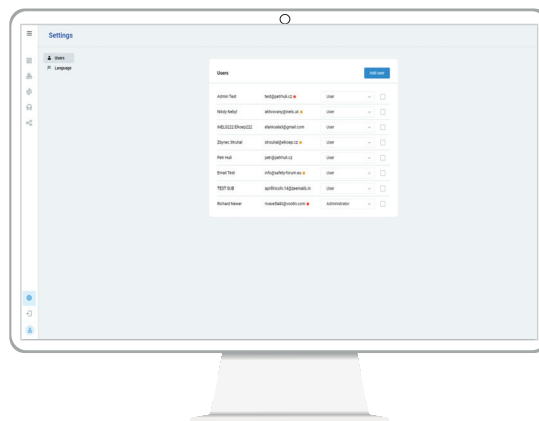

Dashboard

Device overview with the option to view event history.

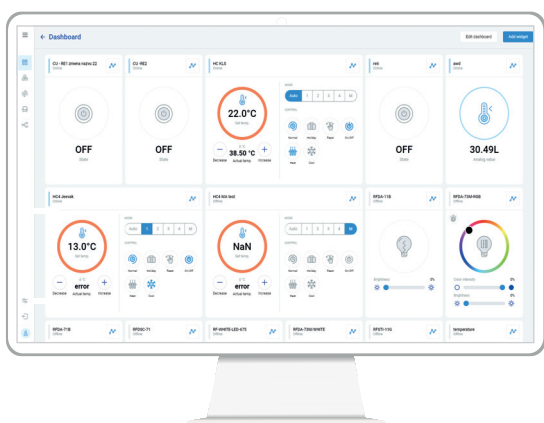

Scenes

Group device control.

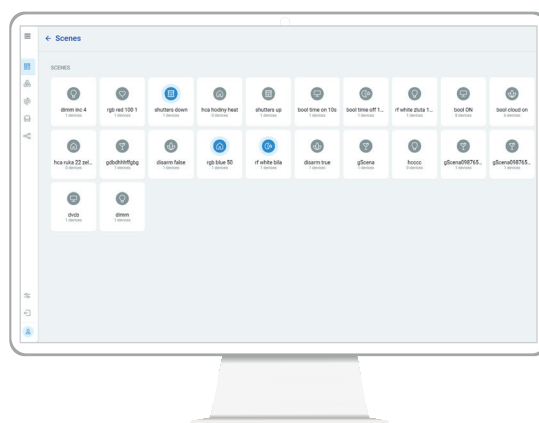

Dashboard

Absolute control over the state of all technologies.



Device list

Control the device from anywhere.

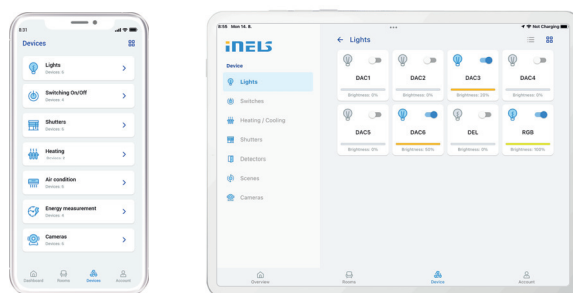

Rooms management

Settings according to individual rooms.

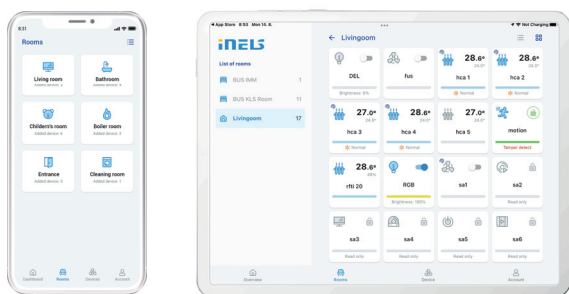

Colour setting

Easy adjustment of the light scene with one touch - switching, dimming, colour.





EAN code
 Telva-2 230V, NC: 8595188181976
 Telva-2 230V, NO: 8595188181969
 Telva-2 24V, NC: 8595188181990
 Telva-2 24V, NO: 8595188181983

Technical parameters	TELVA 230V		TELVA 24V	
	NO	NC	NO	NC
Operating voltage:	230 V, 50/60 Hz		24 V, 50/60 Hz	
Switching current max:	300 mA		500 mA	
Operating current:	13 mA		100 mA	
Closing/opening time:	3–5 min		3–5 min	
Power input:	2.9 W		2.4 W	
Protection:	IP54		IP54	
Settings:	4 mm (0.16")		4 mm (0.16")	
Stopping force:	90–110 N		90–110 N	
Cable length:	800–1000 mm (31–39")		800–1000 mm (31–39")	
Connecting wire:	2 x 0.75 mm ²		2 x 0.75 mm ²	
Media temperature:	-5 °C to 60 °C (23 to 140 °F)		-5 °C to 60 °C (23 to 140 °F)	
Colour:	white RAL 9003		white RAL 9003	
Dimensions h/w/d:	63 x 42 x 45 mm (2.5 x 1.7 x 1.8")		63 x 42 x 45 mm (2.5 x 1.7 x 1.8")	
Connection size:	M30 x 1.5 mm (1.2" x 0.06")		M30 x 1.5 mm (1.2" x 0.06")	

- Thermdrive is intended for opening or closing valves in heating, cooling or air conditioning systems. It is also suitable for use in a floor heating or ceiling cooling manifolds.
- Available in NO (open without voltage), NC (closed without voltage) and for 230 V and 24 V.
- The internal principle of operation of thermdrive mechanism = its movement so that the valve opens/closes is provided by an electric heating element with expansion material, which expands due to temperature changes in the supply voltage.
- Thermdrive is maintenance-free and works completely silently.
- Thermdrive is fitted with a metal nut M30 x 1.5, thanks to which it becomes a 100% fixed part of the valve with this corresponding thread size after installation.
- The stated nut size predetermines the use of a thermocouple with valves from manufacturers such as Herz, HoneyWell, Danfoss, Oventrop and others.

• Telva thermo drive:

- is characterized by absolutely quiet and maintenance-free operation
- is designed for installation - control of heating and cooling systems
- method of mounting the actuator on the controlled valve using an M30 x 1.5 nut
- any working position

• Type of use:

- Floor heating – the RFTC-50/G wireless controller measures the room temperature and, based on the set program, sends a command to the RFSA-66M switching element to open/close the TELVA thermo drive on the distributor.

AN-I | Internal antenna



- into plastic switchboard
- rod angle, without cable
- sensitivity 1 dB
- the internal antenna is included in the standard package

EAN code
 Internal antenna AN-I: 8595188161862

AN-E1 | External antenna



- for mounting into metal switchboard
- cable length 3m
- sensitivity 5 dB
- the external antenna AN-E is supplied on request only

EAN code
 External antenna AN-E: 8595188190121



EAN code			
TC-0:	8595188110075	TZ-0:	8595188110591
TC-3:	8595188110617	TZ-3:	8595188110600
TC-6:	8595188110082	TZ-6:	8595188110594
TC-12:	8595188110099	TZ-12:	8595188110587
		Pt100-3:	8595188136136
		Pt100-6:	8595188136143
		Pt100-12:	8595188136150

Technical parameters	TC	TZ	Pt100
Range:	-20 to +80 °C	-40°C to +125 °C	-30°C to +200 °C
Scanning element:	NTC 12K	NTC 12K	Pt100
Tolerance:	±(0.15 °C + 0.002[t])	±(0.15 °C + 0.002[t])	±(0.3 °C + 0.005[t])
In air/in water:	(τ0.5) ≤ 18 s	(τ65) 62 s/8 s	(τ0.5) -/7 s
In air/in water:	(τ0.9) ≤ 48 s	(τ95) 216 s/23 s	(τ0.9) -/19 s
Cable material:	PVC unshielded, 2x 0.25 mm ²	PVC	shielded silicone 2 x 0.22 mm ²
Terminal material:	polyamid	stainless steel	copper
Protection degree:	IP67	IP67	IP67
Electrical strength:	2500 VAC	2500 VAC	2500 VAC
Insulation resistance:	> 200 MΩ at 500 VDC	> 200 MΩ at 500 VDC	> 200 MΩ at 500 VDC

Types of temperature sensors:

	TC-0	TZ-0	-
- length:	100 mm	110 mm	-
- weight:	5 g	4.5 g	-
	TC-3	TZ-3	Pt100-3
- length:	3 m	3	3 m
- weight:	70 g	106 g	68 g
	TC-6	TZ-6	Pt100-6
- length:	6 m	6 m	6 m
- weight:	130 g	216 g	149 g
	TC-12	TZ-12	Pt100-12
- length:	12 m	12 m	12 m
- weight:	250 g	418 g	249 g

τ65 (95): time, which sensor needs to heat up on 65 (95) % of ambient temperature of environment, in which is located.

- Thermister temperature sensors are made of Negative Temperature Coefficient (NTC) embedded in a PVC or metal sleeve with a thermally-conductive sealer.
- **Sensor TC**
 - lead-in cable to sensor TC is made of wire CYSY 2D x 0.5 mm/0.02".
- **Sensor TZ**
 - cable VO3SS-F 2D x 0.5 mm/0.02" with silicone insulation for use in high temperature applications.
 - silicone insulation for use in high temperature applications.
- **Sensor Pt100**
 - shielded silicon 2x 0.22 mm² (AWG 21), shielding connected with a case.
- temperature sensors can be connected directly to the terminal block
- cable lengths can not be changed, connected or modified.

Resistive values of sensors in dependance on temperature

Temperature (°C)	Sensor NTC (kΩ)	Sensor Pt100 (Ω)
20	14.7	107.8
30	9.8	111.7
40	6.6	115.5
50	4.6	119.4
60	3.2	123.2
70	2.3	127.1

Tolerance of sensor NTC 12 kΩ is ± 5% by 25 °C/77 °F.
Long-term resistance stability by sensor Pt100 is 0.05% (10 000 hours).

Diagramm of sensor warm up via air

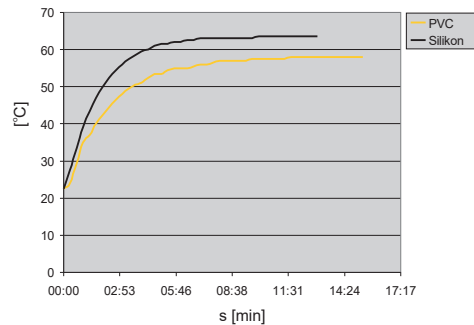

PVC - reaction to water temperature from 22.5 °C to 58°C.
Silicone - reaction to water temperature from 22.5°C to 63.5°C.

Sensor photo

TC



TZ



Pt100



Drawing

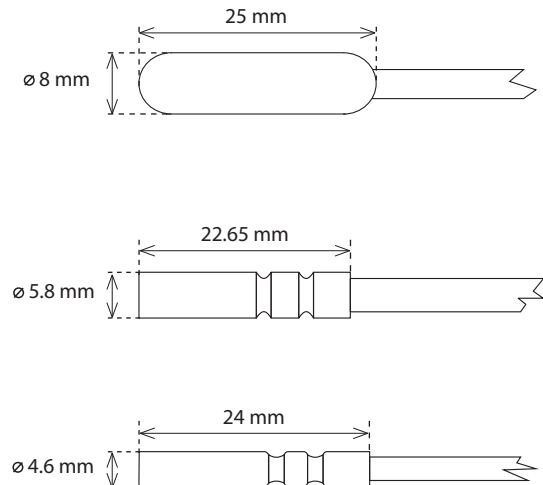

The BUS electro installation iNELS BUS System is a unique solution for electrical installation in the implementation of new projects of houses, villas, apartment buildings, office buildings, hotels, restaurants, wellness centres or perhaps even warehouse or production hall.

The ability to deploy this solution in such a wide variety of different buildings with various purposes and uses lies in its modularity. Thanks to the modular design, the system is very flexible and allows on the one hand, a solution of single-purpose tasks such as control of lighting in restaurants, and on the other hand, solving complex control systems for heating, ventilation, cooling, lighting and shading of office buildings. A complete range of control units designed from glass for management of hotel rooms is in the market unique. Thanks to its modularity is very easy to customize the size of the system and to that effect create a cost effective solution. Smart homes and buildings are accompanied by three basic ideas, namely savings, comfort and safety, the first two ideas may at first glance contradict each other. However, the main objective of smart home or building equipped with the iNELS solution is to attain the optimum indoor environment while achieving the most efficient operation of all system. In homes and buildings the optimal internal environment is very important because people nowadays spend up to 80% of their time inside buildings. It is also shown that indoor environments, where we talk about thermal comfort, lighting comfort and indoor air quality significantly affect the mood and the effectiveness of people.

The iNELS system allows connection of wide range of sensors (temperature, light intensity, carbon dioxide, humidity, and pressure) and detectors (movement, opening doors and windows, gas leakage, smoke, flooding) whose values are constantly evaluated. At the same time iNELS allows the connection of all the technologies that are installed in the building, which continued to significantly increase operational efficiency or comfort, for example; in the case of integrating the guest room management system with the receptionist Fidelio system, which automatically during check-in, sends the room requests for execution, a welcome scene (optimum temperature, comfortable lighting scene, music etc.).

What are the benefits of BUS controlling?

- Save energy by regulating lighting and heating properly
- Control of blinds, awnings, exterior or internal window shutters
- Dimming lights, lighting scenes
- control of appliances or electrical devices
- Control access gates, garage doors
- Logical and central functions (exit button, ...)
- Manual and automatic control mode
- Preventing undesirable opening of a window or a door
- Responding to the movement of people (authorized and unauthorized)
- Remote monitoring via smartphone, tablet or laptop
- Possibility to control via the iNELS Touch Panel 10"
- Integration of third-party devices (cameras, air conditioning, ...)



More systems can be controlled by iNELS:



Push-button wall controller



Glass wall controller



Temperature control



Cloud control

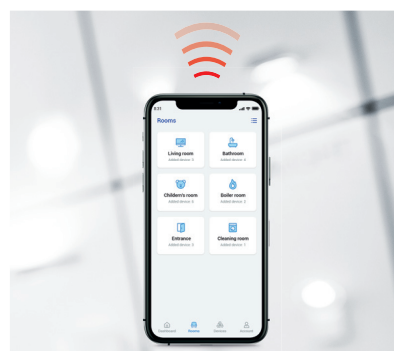

Smartphone

Problematic choice of suitable relay contact for a particular load switched with a product is described below. Mostly we experience problems with incorrect choice of load (meaning incorrect relay for a particular load) which results in permanent switching of contact (sealing) or damage on relay contact – which then results in malfunction. What load can you use? Detailed types of load according to standard EN 60947 are described in charts below – categories of use.

Category of use	Typical use	EN
AC current, $\cos\phi = P/S$ (-)		
AC-1	Non-inductive or slightly inductive load, resistance furnace Includes all appliances supplied by AC current with power factor ($\cos\phi$) ≥ 0.95 Examples of usage: resistance furnace, industrial loads	60947-4
AC-2	Motors with slip-ring armature, switching off	60947
AC-3	Motors with short-circuit armature, motor switching when in operation This category applies to switching off motors with short-circuit armature while in operation. While switching, contactor switches current which is 5 up to 7 times rated current of motor.	60947-4
AC-4	Electro-motors with short-circuit armature: start up, braking by backset, changeover	60947
AC-5a	Switching of electrical gas-filled lights, fluorescent lights	60947-4
AC-5b	El. bulb switching Enables low contact loading due to resistance of cold fiber is many times smaller than the one of hot fiber.	60947-4
AC-6a	Switching of transformers	60947-4
AC-6b	Switching of capacitors	60947-4
AC-7a	Switching low inductive loads of home appliances and similar applications	60947
AC-7b	Load of motors for home appliances	60947
AC-8a	Switching of hermetically sealed motors of cooling compressors with manual reset switches against overload Hermetically sealed cooling compressors have to be placed in one box without external shaft or shaft padding and motor must operate with cooling liquid	60947
AC-8b	Switching of hermetically sealed motors of cooling compressors with manual reset switches against overload Hermetically sealed cooling compressors have to be placed in one box without external shaft or shaft padding and motor must operate with cooling liquid	60947
AC-12	Switching of semiconductor loads with separation transformers	60947-5
AC-13	Switching of semiconductor loads with separation transformers	60947-5-1
AC-14	Switching of low electro-magnetic loads (max.72 VA)	60947-5-1
AC-15	Management of alternating electro-magnetic loads This category applies to switching inductive loads with input for closed electro-magnetic circuit higher than 72 VA Use: switching coils of contactors	60947-5
AC-20	Connecting and disconnecting in unloaded states	60947-3
AC-21	Switching resistive loads, including low loading	60947-3
AC-22	Switching of mixed resistive and inductive loads, including low overloading	60947-3
AC-23	Switching of motor loads or other high inductive loads	60947-3
AC-53a	Switching of motors with short-circuit armature with semiconductor contactors	60947

Note: Category AC 15 replaces formerly used category AC 11

DC current, $t = L/R$ (s)

DC-1	Non-inductive or low inductive load, resistive furnaces	60947-4
DC-3	Shunt motors: start-up, braking by backset, reversion, resistive braking	60947-4-1
DC-5	Series motor: start-up, braking by backset, reversion, resistive braking	60947-4-1
DC-6	Non-inductive or low inductive loads, resistive furnaces – el. bulbs	60947-4-1
DC-12	Management of resistive loads and fixed loads with insulation by opto-electric element	60947-5-1
DC-13	Switching of electromagnets	60947-5-1
DC-14	Switching of electromagnetic loads in circuits with limiting resistor	60947-5-1
DC-20a(b)	Switching and breaking without load(a: frequent switching ,b: occasional switching)	60947-3
DC-21a(b)	Switching ohmic loads including limiting overloading (a: frequent switching ,b: occasional switching)	60947-3
DC-22a(b)	Switching of compound ohmic and inductive loads including limited overloads (e.g. shunt motors) (a: frequent switching, b: random switching)	60947-3
DC-23	Switching of highly inductive loads (e.g. series motors)	60947-3

How can you distinguish for which load is our product (relay) designated?

Our company records this information on a products and also in our catalogue, instruction manual and other promotional and technical material (website etc.).

It is important to realize that it is not always possible to point out load because of lack of information about the device (user cannot measure $\cos\phi$) or it is not possible because of inconsistency of parameters of switched device. Manufacturer of relays records always guaranteed parameters in ideal conditions which are done by a norm (temperature, pressure, humidity, etc.) and reality can be in a lot of cases different. Category of use (classification) of a particular relay is done by material of output contacts.



















Basic types of materials which are used for production of contacts for high-performance relay are:

- AgCd – suitable for switching ohmic loads. Before of harmfulness of Cd, this type of contact is remitted.
- AgNi – designated for switching resistive loads, good quality switching and conducting (contact doesn't oxidate) small currents/voltages, it is not designated for surge currents and loads with inductive component.
- AgSn or AgSnO₂ – suitable for switching loads with inductive component, not suitable for switching small currents/voltages, it is more resistive to surge currents, suitable for DC voltage switching, less suitable for switching loads of ohmic type.
- Wf (wolfram)-special contact designated for switching surge currents with inductive component.
- with gold (AgNi/Au)- Used for "improving" contacts for low currents/ voltages , prevents oxidation.



















Minimum load		
Relay contact	mV	V/mA
AgSnO ₂	1000	10/100

Minimum load		
Relay contact	mV	V/mA
AgNi	300	5/10



















GCR3-11, GCH3-31, GMR3-61, SA3-02B, SA3-06M, WMR3-21, SA3-014M, JA3-014M, RC3-610M/DALI, IOU3-108M

Type of load	 $\cos \varphi \geq 0.95$								
Contact material	AC1	AC2	AC3	AC5a uncompensated	AC5a compensated	AC5b	AC6a	AC7b	AC12
AgSnO ₂ contact 8 A	250 V/8 A	250 V/2.5 A	250 V/1.5 A	230 V/1.5 A (345 VA)	230 V/1.5 A (345 VA) till max output C=14uF	250 W	X	250 V/1 A	250 V/1 A
Type of load									
Contact material	AC13	AC14	AC15	DC1	DC3	DC5	DC12	DC13	DC14
AgSnO ₂ contact 8 A	250 V/3 A	250 V/3 A	250 V/3 A	24 V/4 A	24 V/2 A	24 V/1.5 A	24 V/4 A	24 V/1 A	24 V/1 A



















LBC3-02M, SA3-04M, SA3-022M (RE7 - RE-10), SA3-01B

Type of load	 $\cos \varphi \geq 0.95$								
Contact material	AC1	AC2	AC3	AC5a uncompensated	AC5a compensated	AC5b	AC6a	AC7b	AC12
AgSnO ₂ contact 16 A	250 V/16 A	250 V/3 A	250 V/2 A	230 V/3 A (690 VA)	230 V/3 A (690 VA) till max output C=14uF	1500 W	x	250 V/3 A	250 V/10 A
Type of load									
Contact material	AC13	AC14	AC15	DC1	DC3	DC5	DC12	DC13	DC14
AgSnO ₂ contact 16 A	250 V/6 A	250 V/6 A	250 V/6 A	24 V/8 A	24 V/4 A	24 V/3 A	24 V/8 A	24 V/2 A	24 V/2 A





SA3-02B/Ni*, SA3-06M/Ni*

Type of load	 $\cos \varphi \geq 0.95$								
Contact material	AC1	AC2	AC3	AC5a uncompensated	AC5a compensated	AC5b	AC6a	AC7b	AC12
AgNi contact 8 A	250 V/8 A	250 V/1.5 A	250 V/1 A	230 V/1.5 A (345 VA)	x	400 W	x	250 V/0.5 A	250 V/5 A
Type of load									
Contact material	AC13	AC14	AC15	DC1	DC3	DC5	DC12	DC13	DC14
AgNi contact 8 A	250 V/2 A	250 V/2 A	250 V/2 A	24 V/4 A	24 V/2 A	24 V/1.5 A	24 V/4 A	24 V/1 A	24 V/0.5 A

SA3-06M/Ni*, SA3-04M/Ni*







Type of load	 $\cos \varphi \geq 0.95$								
Contact material	AC1	AC2	AC3	AC5a uncompensated	AC5a compensated	AC5b	AC6a	AC7b	AC12
AgNi contact 16 A	250 V/16 A	250 V/2.25 A	250 V/1.5 A	230 V/3 A (690 VA)	x	800 W	x	250 V/1 A	250 V/10 A
Type of load									
Contact material	AC13	AC14	AC15	DC1	DC3	DC5	DC12	DC13	DC14
AgNi contact 16 A	250 V/4 A	250 V/4 A	250 V/4 A	24 V/8 A	24 V/4 A	24 V/3 A	24 V/8 A	24 V/2 A	24 V/1 A

**SA3-022M (RE1 - RE6, OUT1 - OUT2, RE11 - RE16, SHUTTER),
EA3-022M (RE1 - RE6, OUT1 - OUT2, RE11 - RE16, SHUTTER),
FA3-612M (FAN1 - FAN3, RE)**













Type of load	 $\cos \varphi \geq 0.95$			
Contact material	AC1	AC3	AC15	DC1
AgNi contact 6 A	250 V/6 A	230 V/0.8 A	230 V/1.3 A	30 V/3 A 110 V/0.2 A 220 V/0.12 A

Demonstrated symbols are informative.

*Products with AgNi contact only up on request for extra charge.

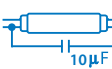
Load	bulbs, halogen bulbs	12–24 V low-voltage bulbs, coil transformers	12–24 V low-voltage bulbs, electric transformers	LEDs/LED strip*	energy-saving fluorescent tubes	control method	
							
	R	L	C	dimmable	dimmable	entering edge	trailing edge
DA3-22M	•	•	•	•	•	•	•
DA3-66M	•	•	•	•	•	•	•
DA3-03M/RGBW	-	-	-	•	-	-	-

Explanations

	El. bulbs loads: el. bulb, halogen light	(R)		Elektronic ballasts for fluorescent	(L)
	Dimmer with defined load: R - resistive, L - inductive, C - capacitive			Inductive loads (transformers): ferromagnetic and toroid transformers for lights with various voltage.	
	Fluorescent light: fluorescent lights uncompensated			Switch: switch - control contact of various device	
	Fluorescent light: fluorescent light compensated in series			Button: control button	
	Fluorescent light: fluorescent light compensated in parallel			Control module: analog control module 0 - 10 V	
	Fluorescent light: fluorescent light economical			Motor	

Category of use	Typical use
-----------------	-------------

AC current, $\cos\phi = P/S$ (-)

AC-1	Non-inductive or slightly inductive load, resistance furnace. Includes all appliances supplied by AC current with power factor ($\cos\phi$) ≥ 0.95 . Examples of usage: resistance furnace, industrial loads.
AC-2	Motors with slip-ring armature, switching off.
AC-3	Motors with short-circuit armature, motor switching when in operation. This category applies to switching off motors with short-circuit armature while in operation. While switching, contactor switches current, which is 5 up to 7 times rated current of motor.
AC-5a	Switching of electrical gas-filled lights, fluorescent lights.
AC-5b	El. bulb switching. Enables low contact loading due to resistance of cold fiber is many times smaller than the one of hot fiber.
AC-6a	Switching of transformers.
AC-7b	Load of motors for home appliances.
AC-12	Switching of semiconductor loads with separation transformers.
AC-13	Switching of semiconductor loads with separation transformers.
AC-14	Switching of low electro-magnetic loads (max. 72 VA).
AC-15	Management of alternating electro-magnetic loads. This category applies to switching inductive loads with input for closed electro-magnetic circuit higher than 72 VA. Use: switching coils of contactors.

Note: Category AC 15 replaces formerly used category AC 11.

DC current, $t = L/R$ (s)

DC-1	Non-inductive or low inductive load, resistive furnaces.
DC-3	Shunt motors: start-up, braking by backset, reversion, resistive braking.
DC-5	Series motor: start-up, braking by backset, reversion, resistive braking.
DC-12	Management of resistive loads and fixed loads with insulation by opto-electric element.
DC-13	Switching of electromagnets.
DC-14	Switching of electromagnetic loads in circuits with limiting resistor.



1) Surface mounted

Wall mounted in an installation box with spacing of 65 mm.

EST4	GSB3-40/S	WSB3-20H
EHT3	GSB3-60/S	WSB3-40
GBP3-60x	GSB3-90/S	WSB3-40H
GCR3-11	MSB3-40	
GCH3-31	MSB3-60	
GRT3-50	MSB3-90	
GSB3-40	GSP3-100	
GSB3-60	GMR3-61	
GSB3-80	IDRT3-1	
GSB3-90	WMR3-21	
GSB3-20/S	WSB3-20	

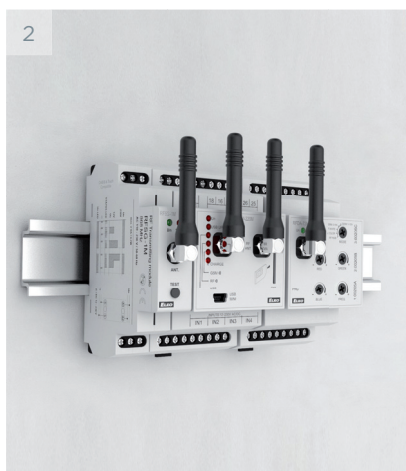

2) DIN Rail mounted

On DIN rail according to EN 60715.

ADC3-60M	LBC3-02M
CU3-07M	PS3-30/iNELS
DA3-66M	PS3-100/iNELS
DA3-22M	SA3-04M
DAC3-04M	SA3-06M
EMDC-64M	SA3-014M
FA3-612M	SA3-022M
IM3-140M	TI3-60M
IOU3-108M	
JA3-014M	

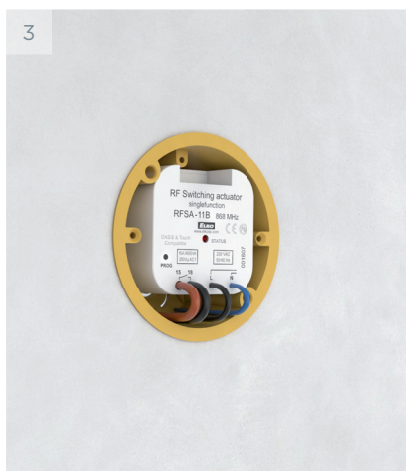

4) Mounted to or in the installation box

Mounted in an installation box or built into the device.

IM3-40B	SA3-01B
IM3-80B	SA3-02B
	TI3-40B



4) Mounted into the cover of appliance

SA3-01B
SA3-02B



5) Surface mounted

Other attachment options.

DLS3-1



6) Ceiling mounting

MCD3-01
PMS3-01

1-MODULE

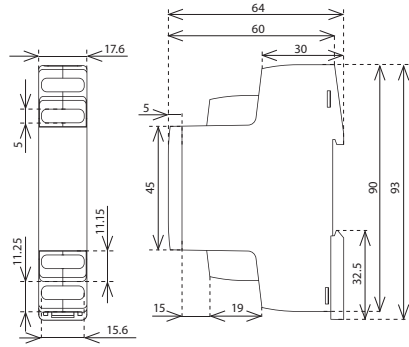

- BPS3-01M
- BPS3-02M
- CU3-07M
- CU3-08M
- CU3-09M/DALI
- CU3-10M
- iNELS Bridge

3-MODULE

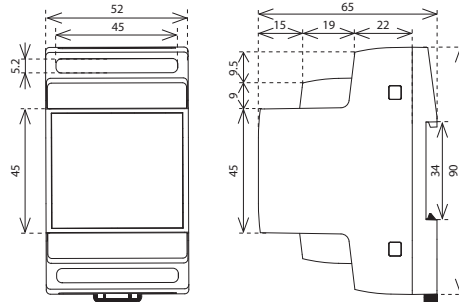

- ADC3-60M
- DA3-22M
- DAC3-04M
- EMDC-64M
- IM3-140M
- LBC3-02M
- PS3-30/iNELS
- SA3-04M
- SA3-06M
- TI3-60M
- DA3-03M/RGBW

6-MODULE

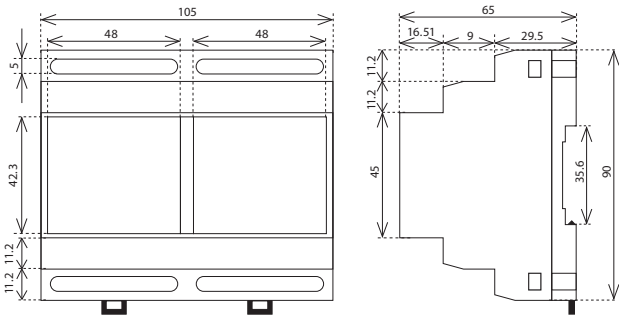

- DA3-66M
- EA3-022M
- FA3-612M
- IOU3-108M
- JA3-014M
- SA3-014M
- SA3-022M
- RC3-610M/DALI
- RC3-612M

BOX

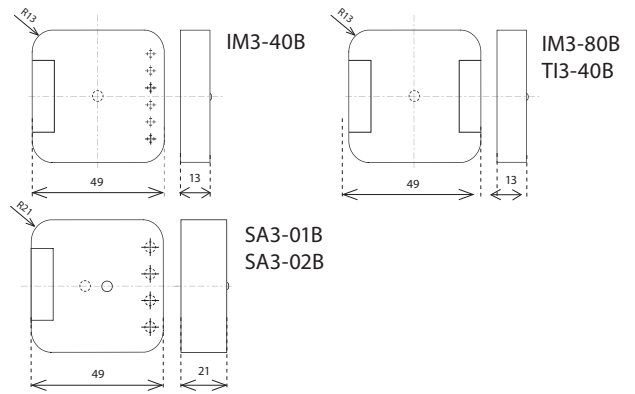

IM3-40B

IM3-80B
TI3-40B

SA3-01B
SA3-02B

PSM3

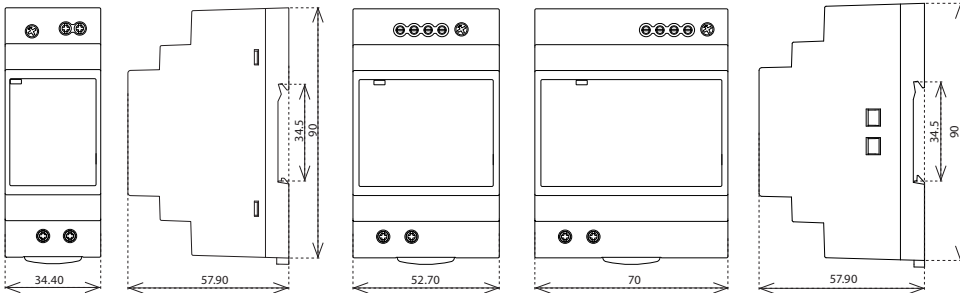

- PSM3-30
- PSM3-60
- PSM3-100

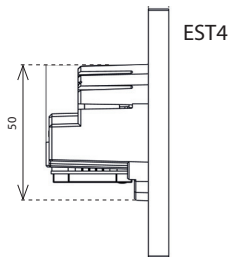
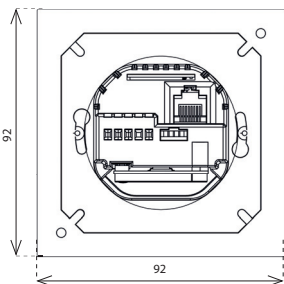

EST4

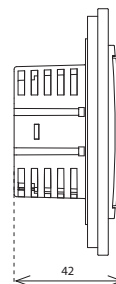
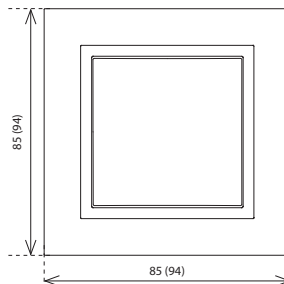

- WSB3-20
- WSB3-20H
- WSB3-40
- WSB3-40H
- WMR3-21

IDRT3-1

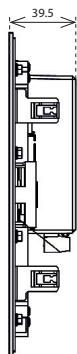
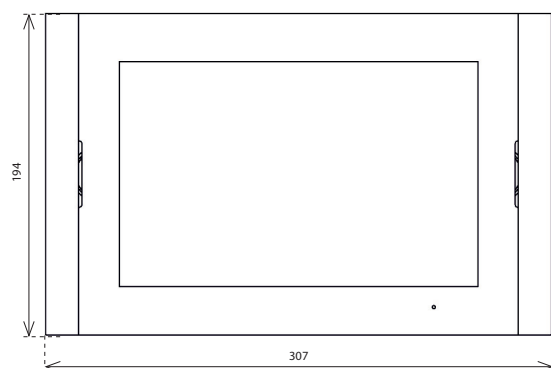

iNELS TOUCH iA10

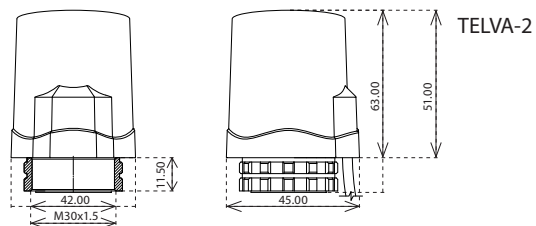
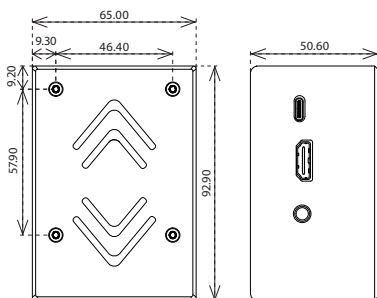
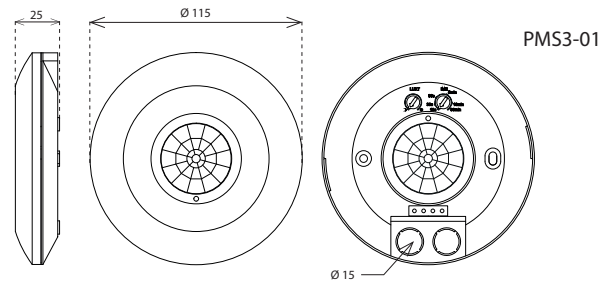
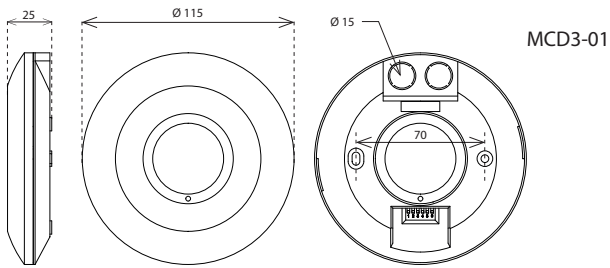
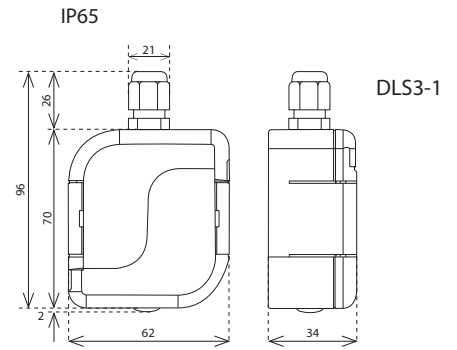
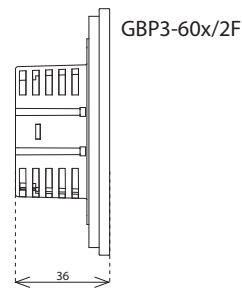
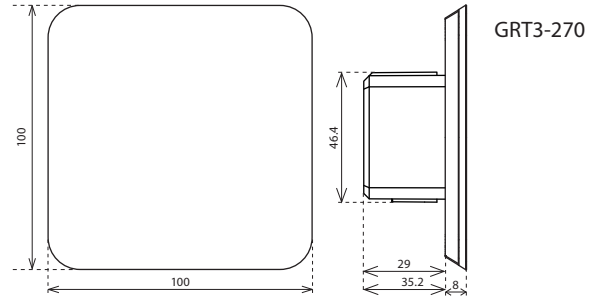
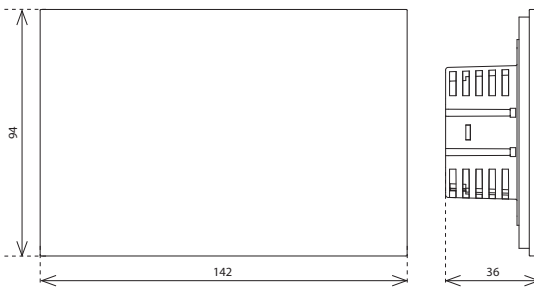
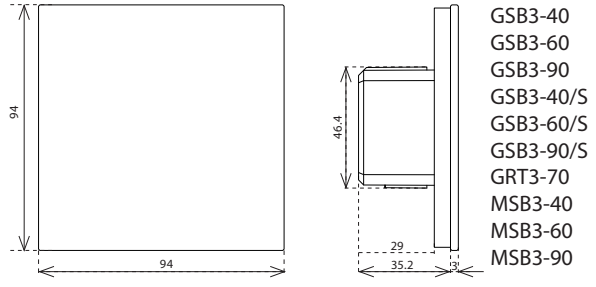
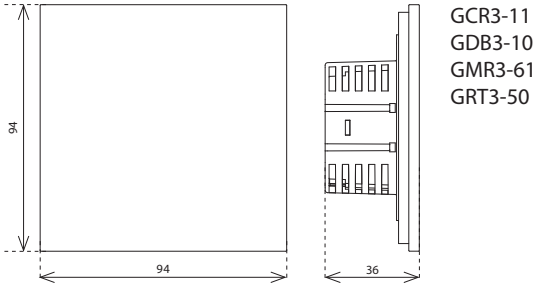



● **Headquarters**

ELKO EP Holding SE, Czech Republic

● **Europe**

ELKO EP Balkan d.o.o
ELKO EP Bulgaria OOD
ELKO EP Germany GmbH
ELKO EP Hungary Kft.
ELKO EP POLAND Sp. z o.o.
ELKO EP SLOVAKIA, s.r.o.
ELKO EP UK Ltd.
ELKO EP UKRAINE LLC

● **Africa & Middle East**

ELKO EP Egypt LLC
ELKO EP Kuwait Ltd.
ELKO EP MEA LLC
ELKO EP Saudi Arabia Ltd.
ELKO EP South Africa PTY
Ltd.

● **America**

ELKO EP North America LLC



ELKO EP, s.r.o. | Palackeho 493 | 769 01 Holesov, Vsetuly | Czech Republic
phone: +420 573 514 221 | fax: +420 573 514 227 | elko@elkoep.com | www.elkoep.com

Published: 09/2023 | Modifications or amendments reserved | © Copyright ELKO EP, s.r.o. | 1st edition