

Highlights Autumn 2019

News from iNELS & ELKO EP World



www.elkoep.com

NEWS

IMPROVED AND NEW PRODUCTS

Relays, switches & more

ENERGY GATEWAY APPLICATION

Improved app for RFPM-2

iNELS HOME CONTROL

Control iNELS via TV

iNELS Air

Our NB-IoT sensors in networks of other operators
Collaboration with Clever Farm

HOW TO CONTROL A/C BY iNELS?

BUILDING MANAGEMENT SYSTEM

iDM v.3.3.34 | Niagara Framework | Flowbox | Promotic

INVITATIONS TO FAIRS

ELEC EXPO | VSK | LIGHT + BUILDING

REFERENCES

The logo for iNELS, featuring the word "iNELS" in a bold, white, sans-serif font with a registered trademark symbol (®) to the right.

www.inels.com

Content

a selection of topics you shouldn't miss

- PRODUCTS PORTFOLIO 4-5
- IMPROVED AND NEW RELAYS 6-11
 - Bistable relay
 - Innovation of function and design
 - Dimming of LED light sources
 - New range of monitoring relays
 - Quick overview of monitoring relays
- AUTOMATIC LIGHTING CONTROL OF HOTEL ROOMS 12
- IN-GLASS SWITCH WITH INTEGRATED DIMMER AND WIRELESS CONTROL 13
- RFIO² - UPGRADED WIRELESS PROTOCOL 14
- SERVICE KEY RFAF/USB 15
- RFPM-2 – ENERGY GATEWAY WITH IMPROVED APPLICATION 16-17
- CONTROL INELS VIA TV 18-19
- INELS AIR 20-21
 - Our NB-IoT sensors in networks of other operators
 - Collaboration with Clever Farm
- HOW TO CONTROL A/C BY INELS? 22-23
- BUILDING MANAGEMENT SYSTEM 24-34
 - iDM v.3.3.34
 - Building
 - Promotic
 - Niagara Framework
 - FLOWBOX
 - Overview table
- INELS BUS FOR IRIDIUM MOBILE 35
- DEMONSTRATING THE POSSIBILITIES OF INELS RF CONTROL 36
- COME TO SEE OUR INNOVATIONS 37
- NEW REFERENCES 38-40
- NOTES 41
- ABOUT ELKO EP 42-44
 - Facts and stats
 - Others just resell
 - ELKO EP Holding



Improved and new relays ... see pages 6-11



In-glass switch with integrated dimmer and wireless control ... see page 13



Energy gateway application Improved app for RFPM-2 ... see pages 16-17



Control iNELS via TV ... see page 18-19



iNELS Air Our NB-IoT sensors in networks of other operators Collaboration with Clever Farm ... see page 20-21



Building management system iDM v.3.3.34 | Promotic | Flowbox | Niagara Frameworks ... see page 24-34

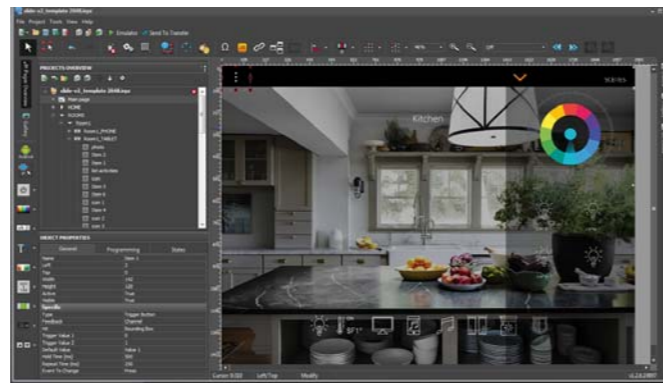

iNELS BUS for iRidium Mobile ... see page 35



Demonstrating the possibilities of iNELS RF Control ... see page 36



Come to see our innovations ELEC EXPO | VSK | LIGHT + BUILDING ... see page 37

Products Portfolio

Timers / Relays



A wide range of electronic modular devices, which bring new possibilities to home and office control, monitoring and security, as well as to industrial process control: time relays, installation contactors, staircase automatic switches, time switches clocks, thermostats, power supplies units, etc.

Protection monitoring relays



Every household, every object and every machine needs a monitoring relay. There are several reasons why, overvoltage, undervoltage, phase failure, asymmetry, frequency, or power factors.

iNELS Air - IoT devices



iNELS Air is a response to the dynamically developing network for IoT (Internet of Things). The product group includes sensors and detectors for communication on the Sigfox, LoRa and NB-IoT protocol.

Wireless home automation



The system uses wireless communication between devices. The installation itself is variable thanks to this communication and can be gradually expanded.

Wired home automation



The BUS system offers a unique solution for new installations in family houses, hotels and villas. It offers a wide range of functions for both automation and comfort.

Energy management



Measuring energy consumption in the home or in larger areas is an increasing trend. Our products provide measurement with three different technologies - using a BUS or wireless system and thanks also with the IoT.

Hotel Wireless Retrofit



Hotel Room Energy Saving Kit - Solutions for hotel rooms based on wireless technology is designed to function in existing hotels. It is possible to simply elevate the existing electrical installation to a higher level without long-lasting construction modifications.

Guest Room Management System



Guest Room Management System - The BUS system is designed mainly for hotels and offers comfortable and easy control of hotel rooms, reception and restaurant.

Building management system



Building Management System is a comprehensive solution for monitoring, and controlling even the most complex of building systems. You can monitor everything on your computer monitor or tablet in the comfort of reception or office.

Lighting control



A sector that offers complete control over all lighting devices. From switching, dimming to controlling your favourite DALI luminaires. Everything can be controlled with a connection to iNELS wired or wireless technology.

Multimedia



Here you can find extensions for our iNELS system and not just for it. Lara Music Players, Intercoms and Door Communicators, Application Communication Servers and 3rd party applications.

Switches and sockets



This portfolio covers a variety of colorful and elegant accessories suitable for interior use or even more demanding areas such as workshops or industrial objects.

Bistable relay

- Often referred to as “impulse”.
- Bistable relays are used mainly for remote lighting control from multiple places, heating ...
- The advantage of these devices is silent switching and zero consumption energy in closed state.
- Manual control for BR-220-20 and BR-232-20.
- Due to surge current (up to 80 A for BR-232-20), LED lamps are more suitable for switching drivers.
- Bistable relays have a load of 6-10 A higher than conventional contactors due to the switching of LED lamps.
- In a conventional lighting control installation, a large amount of cables is used but for bistable relays they are used for signal control only 2 wires. As a result, the bistable relay provides savings during installation (cable consumption, installation time ...)



New

Maximum number of LED lamps per pole at 230 V, 50 Hz		
BR-216-10/11/20	BR-220-20	BR-232-20
max. 2 A per pole	max. 6 A per pole	max. 12 A per pole

In configuration of NO/NC contacts:

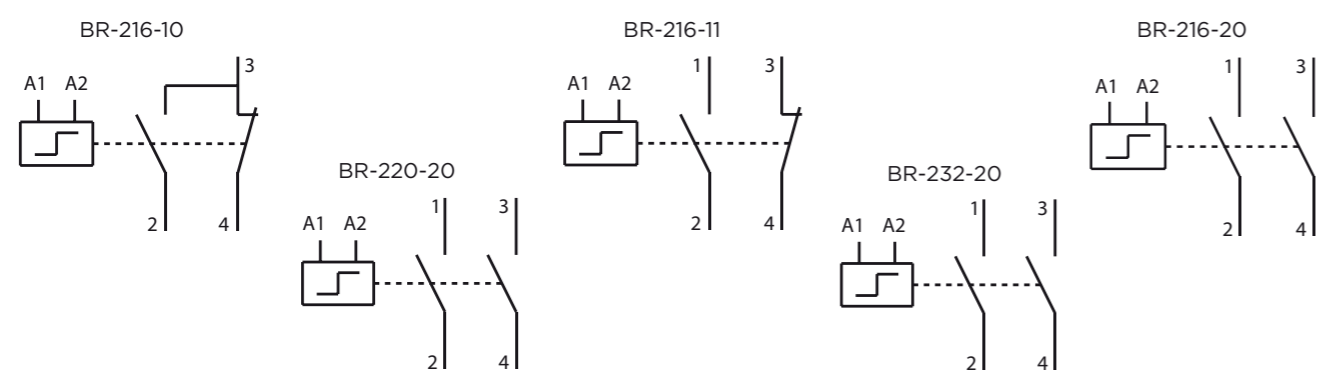

Innovation of function and design

Staircase switch CRM-4

Programmable staircase switch CRM-46

innovation

New

Connection of glow lamps / LED switches up to 100 mA.



LED timing signalling on the device.

Switch time programming function by number of button presses.

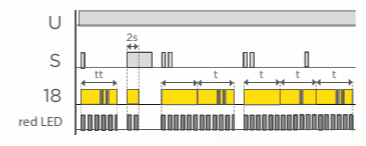

Possibility to set the signalling flashing light before switching off.

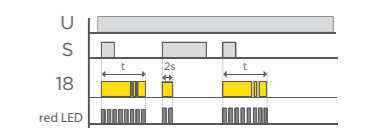

The function Turns off the lights before the time runs out.

New function Pulse relay with delayed return (function for those who forget to switch off when they go out = goes out by itself).



New design

- Higher stability of DIN rail mounting due to reinforced spring on the latch which brings vibration resistance.
- Larger front slots for easier wire gripping and a fixed top latch to speed up assembly.
- Special material Xantar MX 1094 ensures high UV stability and longer life.

Dimming of LED light sources

It is said that LED light sources are TOP of the market and are now used in 80% of buildings and homes to save costs. However, it is more difficult to define the load of LED sources on the dimmer with the aim of trouble-free regulation.





Each dimmer has overcurrent protection that reacts at a certain peak current. Each load (bulb, LED, energy saving lamp) has a certain power consumption. This is usually stated on the packaging by the manufacturer. However, the peak current value of this load is usually not stated. This is because each LED or energy saving lamp has electronics inside, peak current values may vary considerably for different products. Generally, it is not possible to determine the number of individual LED bulbs, if we do not know this value; we can only test a specific number of pieces.

The solution to the determination this is by the power factor $\cos \phi$. The power factor of dimmable LED lamps ranges from: $\cos \phi = 0.95$ to 0.4 . You can get the approximate max. Load value by multiplying the dimmer load and the power factor of the connected light source.

energy saving lamp has electronics inside, peak current values may vary considerably for different products. Generally, it is not possible to determine the number of individual LED bulbs, if we do not know this value; we can only test a specific number of pieces.

LED dimmers ELKO EP excel in parameters:

Setting the light source type.

- R  HAL 230V bulbs, halogen lamps
- L  low-voltage el.bulbs 12/24V wound transformers
- C  low-voltage el.bulbs 12/24V electronic transformers
- ESL  ESL dimmable compact fluorescent lamps
- LED  dimmable LED bulbs

Set the minimum brightness to eliminate the flicker of the light source (especially the LED).

Load 160 W.

Brightness level will be saved to dimmer memory when powered off and restored when powered on again.

Possibility to connect up to 20 buttons with LED lamp (0.7 mA).

 Integrated electronic thermal fuse. In case of reaction no exchange is necessary.

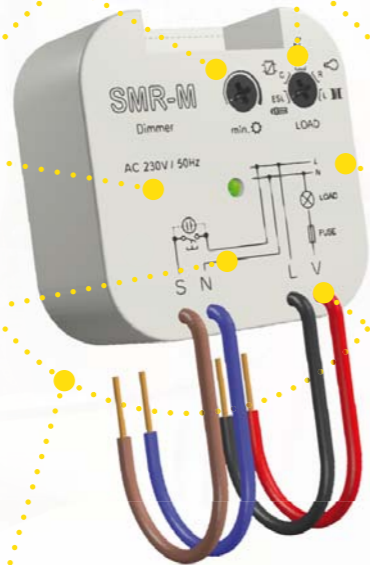

Universal dimmer SMR-M

Button control dimmer.

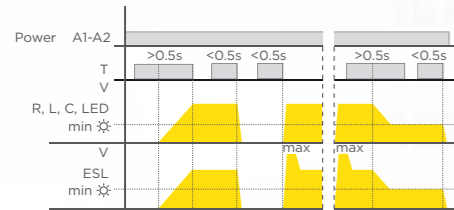

Dimmers

New range of monitoring relays

Lower power consumption of 1.5 W compared to normal competition (> 3 W).

Ability to measure with an accuracy of 2% (normal competition $\geq 5\%$).

With 24-240 V AC / DC power supply, **no additional power supplies are required.**

Thanks to the **galvanically isolated auxiliary power supply (AUX)**, the relay function is maintained even in the event of a failure of the monitored voltage. This keeps the status of the monitored circuit continuously maintained.

Up to **6 finely adjustable voltage monitoring ranges** per device.



Protection/Monitoring relays

The monitoring voltage relay ranges cover the nominal values of 1-phase and 3-phase voltages in various countries of the world - America | Europe | Asia | Australia | Africa.

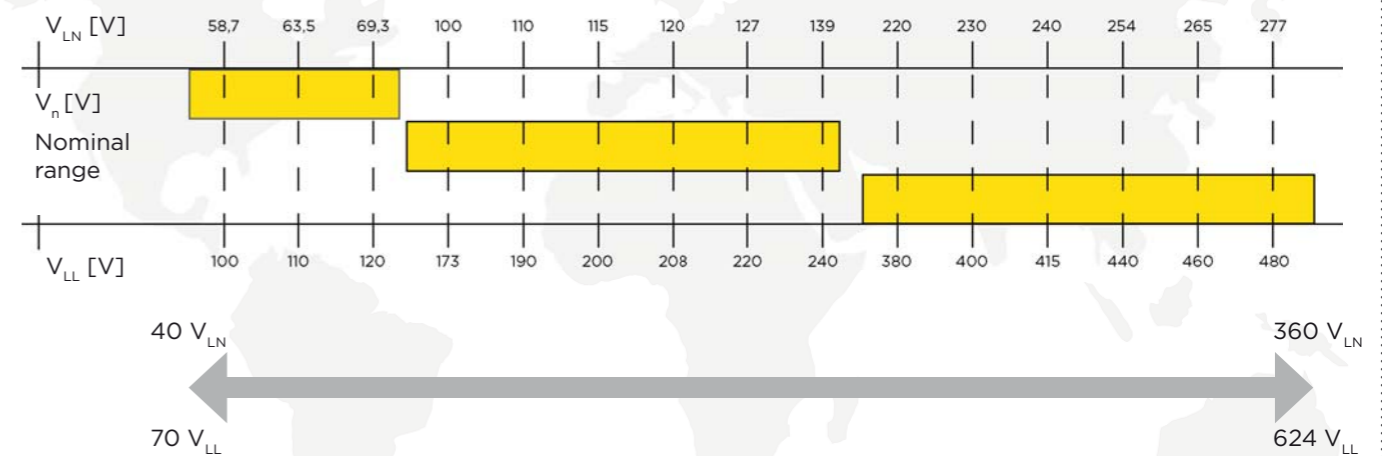

LEGEND: V_{LN} Voltage between phase and neutral
V_{LL} Voltage between phases

Automatic lighting control of hotel rooms

The guests in the hotel rooms do not care about the energy costs: "it is not their consumption and they don't have to pay for it." Therefore, they leave the lights, TV and other appliances switched on even in the absence (e.g. breakfast). The card switches tried to prevent this, but it turned out to be inefficient because of the replacement of cards in the switch with business cards, or in the case of RFID by simply asking for a replacement card at the reception. This problem is not only for hotel guests, but also for the hotel's own cleaning services, which may not be targeted: "they just forget to turn off." The automatic lighting control system prevents unnecessary lighting in the absence of persons. This saves energy costs, significantly.

When entering a hotel room, the RFDW-100 wireless door detector detects the door opening and sends a command to the RFSA-161B switch to turn on the light for a set time (e.g. 3 minutes). The person entering the room is detected by the motion detector RFMD-100 and a command is sent to the RFSA-161B switching device to override the door detector command. In the room (and in the bathroom) movement is monitored continuously by means of motion detectors, and thus the light stays on. If the person leaves the hotel room = movement is not detected and at the same time, the door is closed by the door detector, a command to turn off the light is sent (in the case of no movement detected). When the guest goes to sleep, press the "Master OFF" button on the RFWB-40 wireless controller to turn off the illumination and deactivate the automatic lighting control function in the background. In the morning,



pressing the button to turn on the illumination on the RFWB-40 wireless controller in the background activates this function.

Thanks to the integrated terminals, the RFSA-161B switchgear allows you to connect existing buttons in your installation, eliminating the need to remove the buttons during renovation.

In the hotel room there are other appliances such as lamps, sockets, curtains, which you control through other RFSA switching and dimming RFDEL components with RFWB-40 wireless buttons.

Cooling / heating control is an essential part of the hotel room renovation. The RFSA-166M switching component is a peripheral unit for controlling the fancoil type of temperature control. It is an integral part of the thermostat RFTC-150G, which thanks to the flat base allows quick assembly and is available in 36 colours. It is combined with an RFDW-100 door detector to turn off cooling / heating when a window or balcony door is opened. In addition to the temperature control, the RFSTI-11B temperature device monitors the maximum room temperature (e.g. 32 °C). Especially in warm countries and hot days, the room temperature may rise above 30 °C, resulting in the destruction of furniture by dry air. Conversely, nonstop air conditioning (if there is no person in the room for more than a day) causes unnecessary costs. An essential advantage of the implementation of this system is not only savings in energy consumption, but also quick assembly (within two hours), and without the need to close the room, which would cause a financial loss to the hotelier.

In-glass switch with integrated dimmer and wireless control

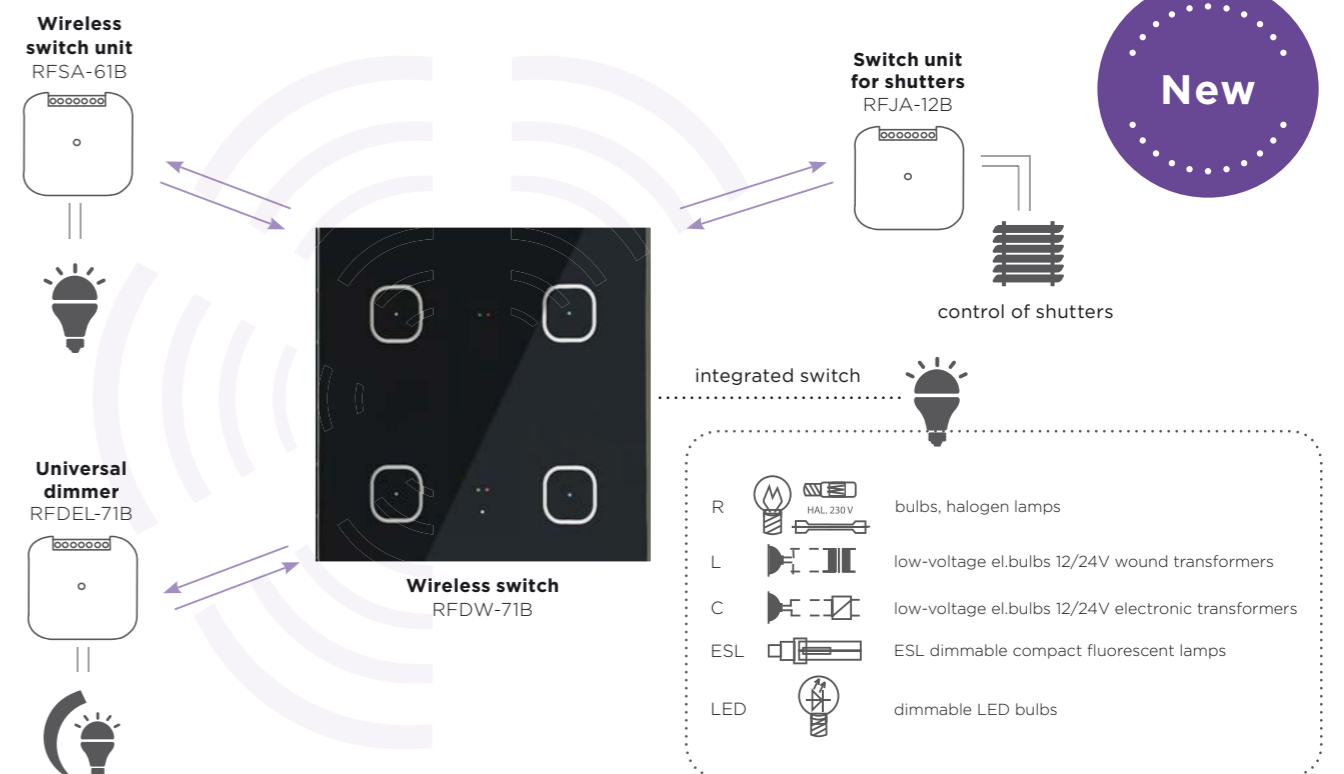

RFIO² - upgraded wireless protocol

Preventing the possibility of unsuccessful setting / collision of pairing with an unwanted device

It is achieved through programming buttons on the wireless switch.

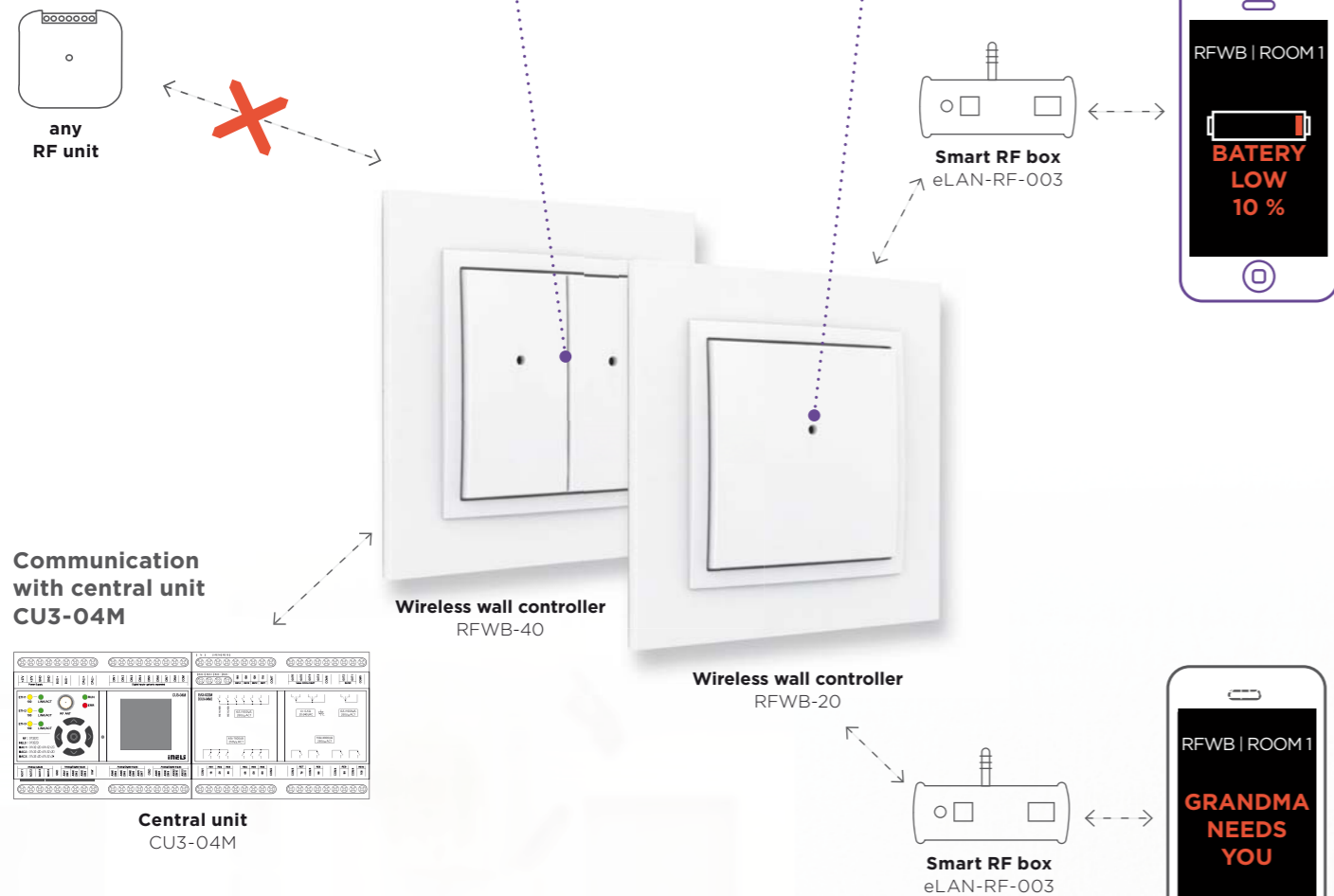

Battery Discharge Signalling

When the battery charge level is below 10%, the wireless switch will flash 3 times every minute.



Communication with central unit CU3-04M

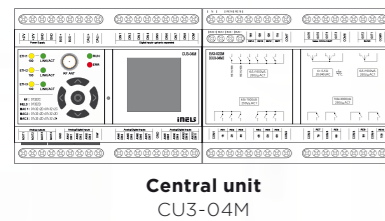

Labelling of iNELS RF elements with RFIO² protocol

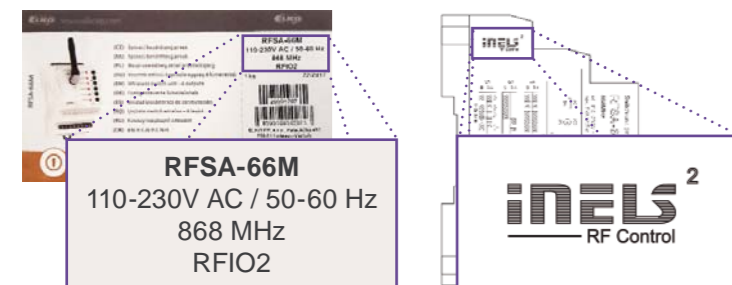

Panic button

When the button is pressed, the information is sent to the smartphone via the eLAN-RF-003 smart box.

Service key RFAF/USB

The RFAF / USB Service Key is a support tool for system partners and installers to facilitate setup and analyse wireless communication problems.

Setting the repeater signal through iNELS RF components with the RFIO² protocol, which increases the range of communication by hundreds of meters.

The RF communication network analyser reliably analyses the communication between the controller (where you plan to place it) and the component in the installation. Shows signal strength / quality as well as frequencies that can interfere with communication. This gives you an overview of interference and weak signal points that you can avoid during installation. You can avoid these situations simply by repositioning the component.

Available frequency for individual territories:

- 866 MHz** India
- 868 MHz** EU, UA, RU, Middle east
- 916 MHz** North / South America, Australia, New Zealand



Repeater	Unit Address	Unit Type
Repeater 2	019DA7	RFSFA6x
Repeater 1	019DA8	RFSFA6x
MASTER	001818	RFSFA6x

13:18:08.733 - 03.08.2018
 Routing over 2 repeaters (0xF8)
 -> 019DA7 -> 019DA8 -> 001818
 1st Repeater - unit RSSI: -53.5 dBm
 2nd Repeater - 1st Repeater RSSI: -55.5 dBm
 Master - 2nd Repeater RSSI: -41.5 dBm

RFPM-2 – Energy gateway with improved application

The Energy Gateway RFPM-2 web interface now has a completely new and cleaner visualization. This makes displaying and evaluating energy consumption even more convenient and easy.

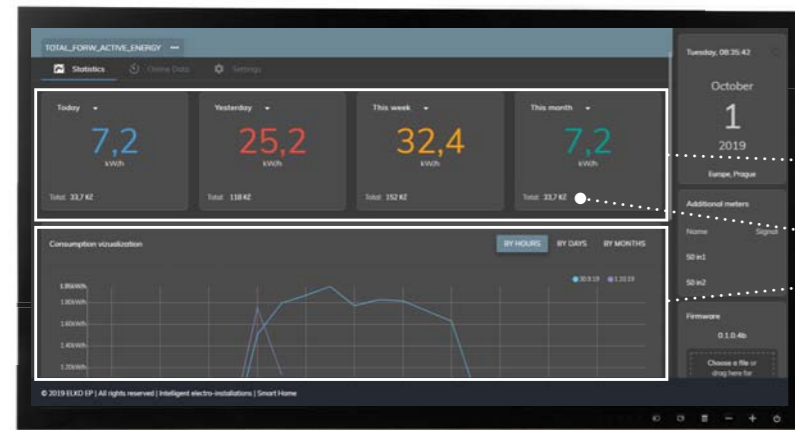

STATISTICS

- Sample overview of electricity consumption (today, yesterday, this week, this month)
- Consumption converted to finance costs
- Graphical visualization of consumption (by hours, days, months)

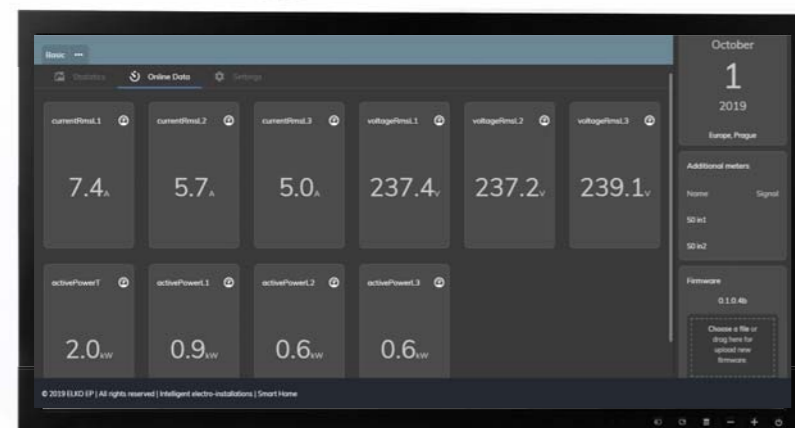

ONLINE DATA

The Energy Gateway evaluates the following indicators in the network:

- Phase current / voltage
- Phase overvoltage / undervoltage
- Asymmetry
- Distortion of the sine wave signal
- Distortion of sine wave signal flow
- Frequency
- Active performance
- Reactive power
- Apparent performance
- Power factor
- Phase voltage shift between phases

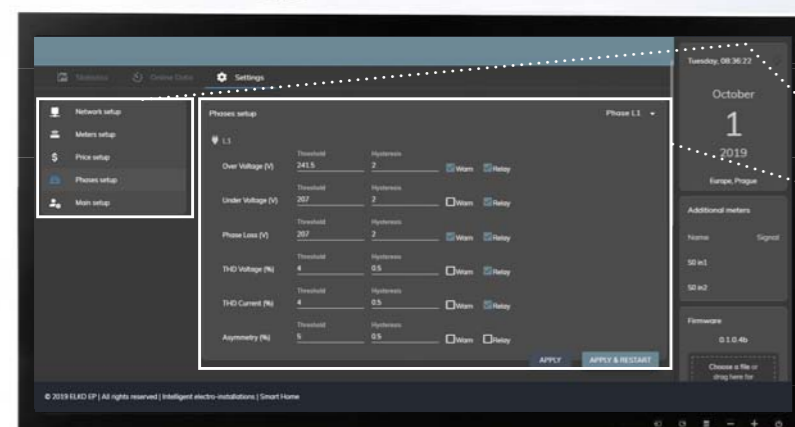

SETTINGS

- Main SETTINGS menu
- Example of "Phase settings" submenu

All basic and advanced settings are made simply, quickly and intuitively. If you have any questions, a telephone/e-mail technical support is available.

DEMO web interface
<http://217.197.144.56:2130/>
 Login and password: **admin**

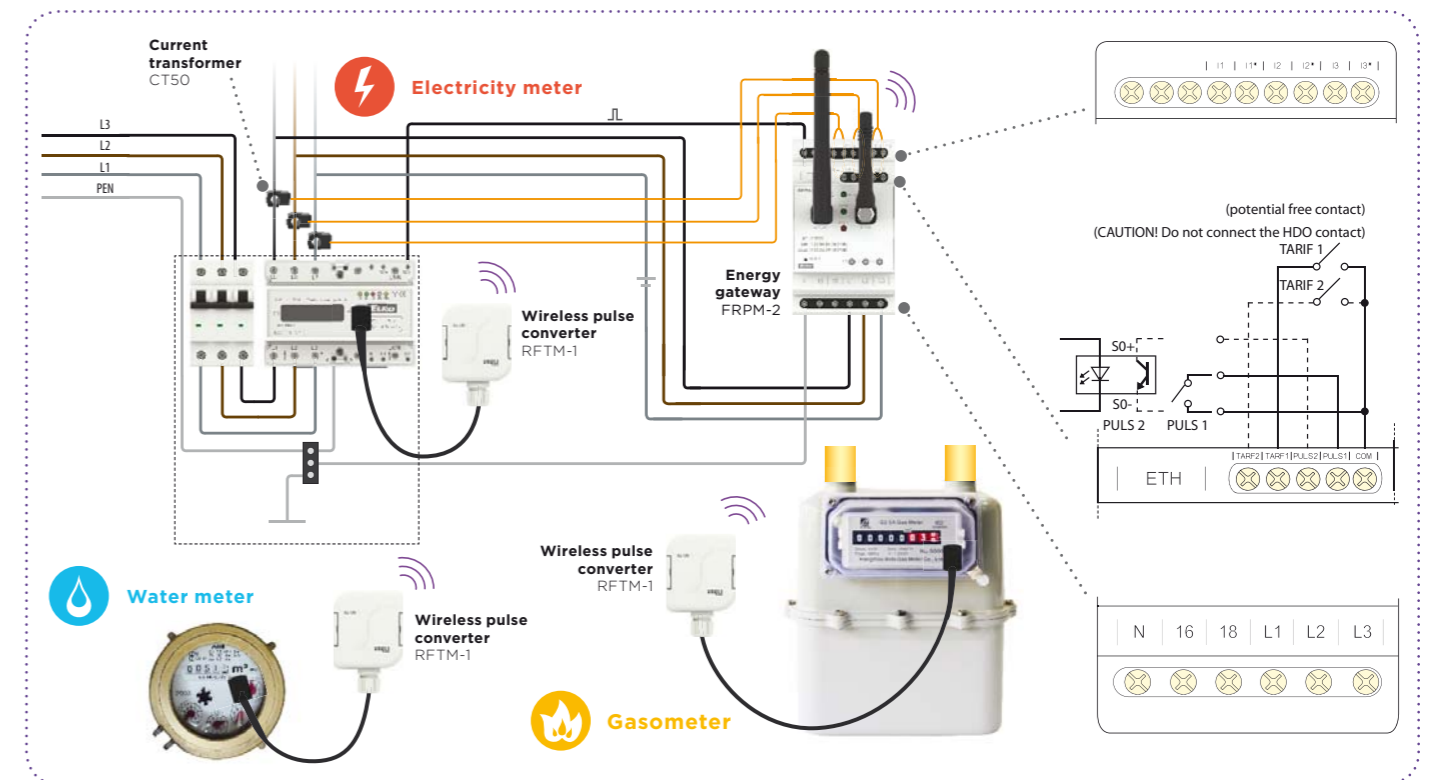

Measured data can be displayed not only through the web interface on the PC, but also in iNELS Home Control (iHC). The measured values of all quantities can be monitored, but above all archived and analysed in many selected time periods (daily, weekly, monthly and yearly). Consumption can be quantified in consumed units or directly in financial costs. Another advantage is the possibility of measuring electricity consumption in up to 4 tariffs.

PROMO APP available



Login and password: **admin**



Current consumption can be displayed as a bar graph.



You can choose to display the consumption in units.



One click to switch to power consumption in your currency.

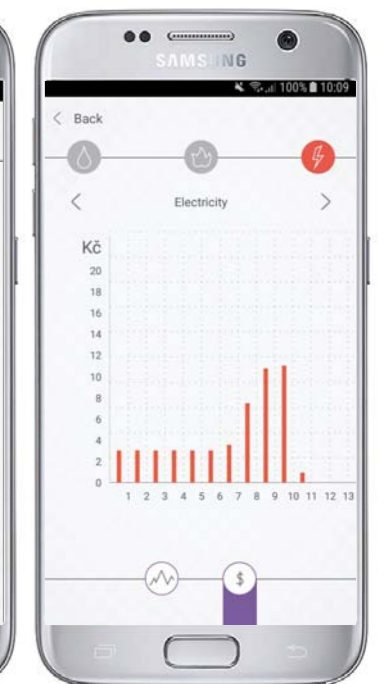

Significant savings can be achieved by analysing data.

Control iNELS via TV

The updated iNELS Home Control application brings a new dimension to the control of households via smart TVs. It is fully compatible with Samsung Smart TV. Thanks to the TV you can control appliances such as lights, air conditioning, heating, ga-

rage doors, cameras, outdoor blinds and more. The application is available for download for Samsung Smart TV owners by logging into Samsung account for free.

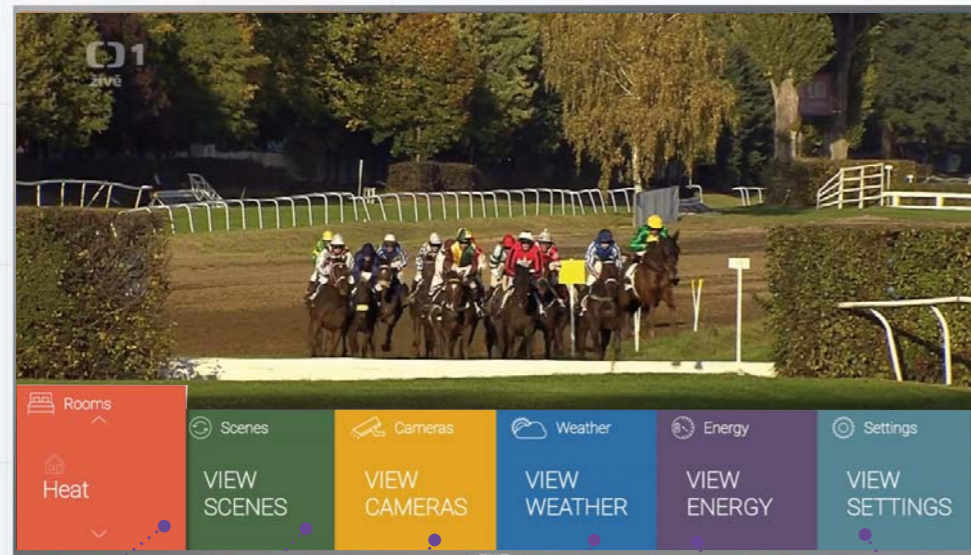

Room selection.

Control of scenes and individual devices in the selected room.

View cameras.

View the weather in a pre-set location.

Display current electricity, water and gas consumption.

Device, camera, weather, energy metering settings.

What you can control:

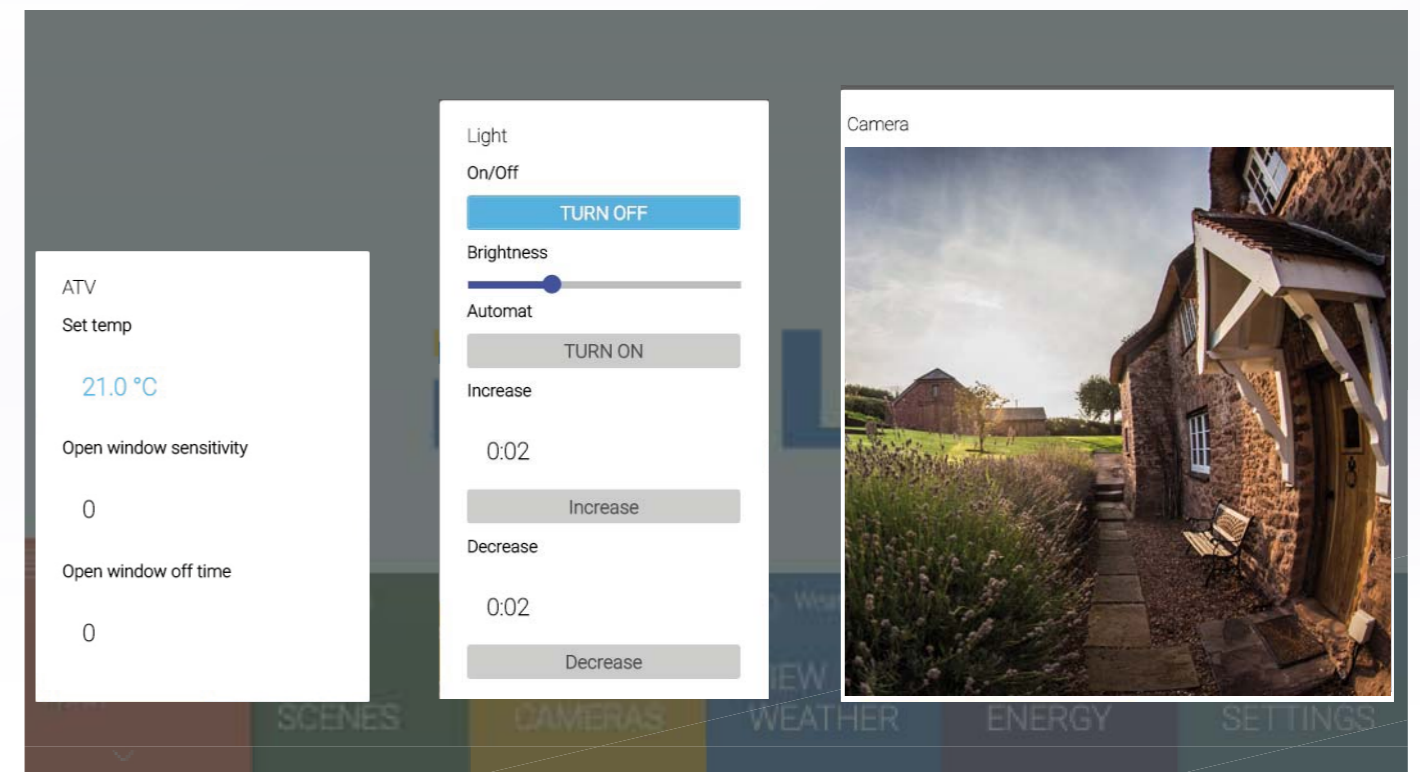
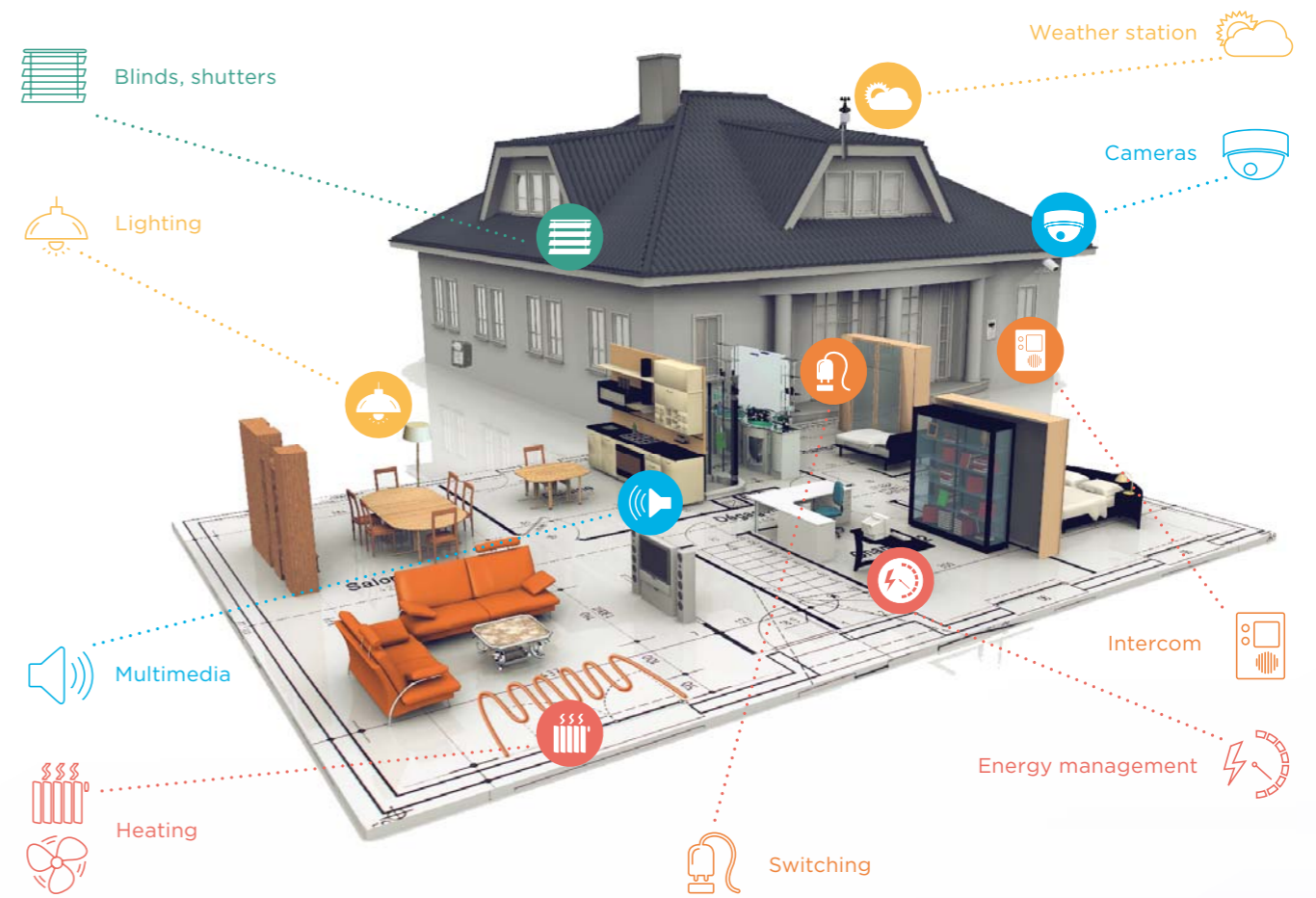

Our NB-IoT sensors in networks of other operators

ELKO EP with iNELS Air products (IoT devices) has tested the operation of its NB-IoT devices with several national and multinational mobile operators as part of testing and pilot projects.

NarrowBand becomes dynamically developing IoT network capable of large-sized extending due to existing mobile network infrastructure based on base transceiver stations.



Our IoT devices are working in those NB-IoT operator networks now:

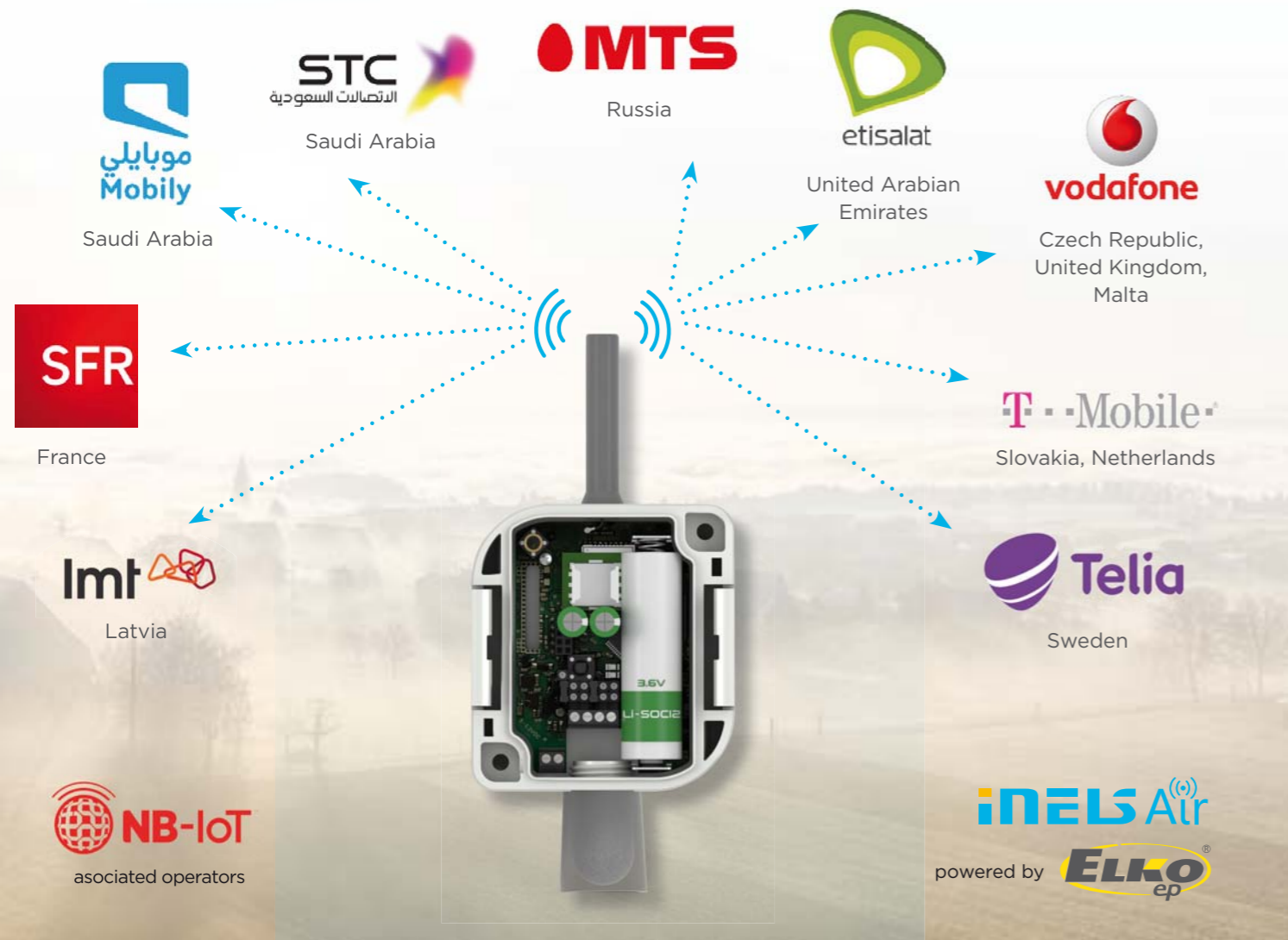

Collaboration with Clever Farm

The very rational use of iNELS Air sensors and detectors has been demonstrated in cooperation with Clever Farm.

Clever Farm is a relatively new company that develops and deploys smart solutions for farmers in various fields.

These solutions include not only agro-evidence (fertilizers, nitrate compliance), maps linked to satellite

imagery (allowing precise farming), land records (for lease and barter contracts), but also links to IoT sensors that provide a constant overview of soil conditions, forests and post-harvest warehouses.

ELKO EP has developed and manufactures customized devices based on iNELS Air sensors.

These are connected to the Clever Farm platform via SigFox / LoRa / NB-IOT networks.

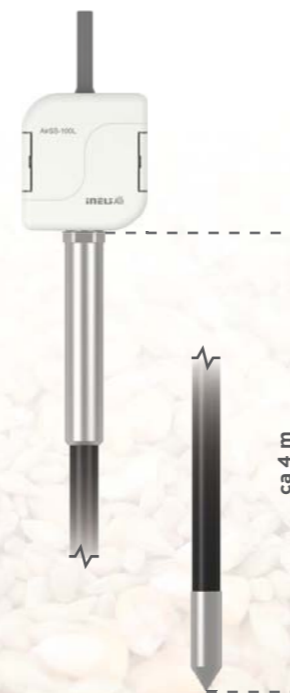

Temperature of stored harvest
AirSS-100



Soil moisture
AirSS-100



Humidity, temperature and atmospheric pressure
AirCFS-100

How to control A/C by iNELS?



Smartphone app view (iHC-MA/MI)



Tablet app view (iHC-TA/TI)

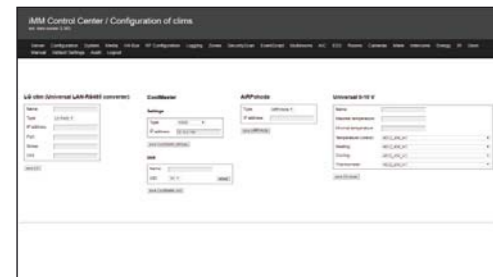

iMM Control Center setup screen

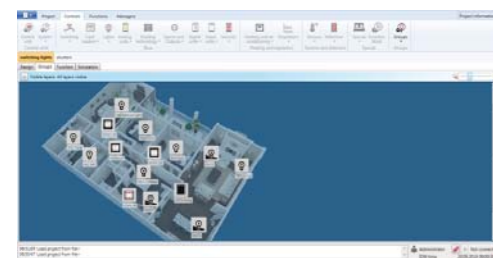

iMM Control Center setup screen



EHT3 screen

CU3-01M



BUS

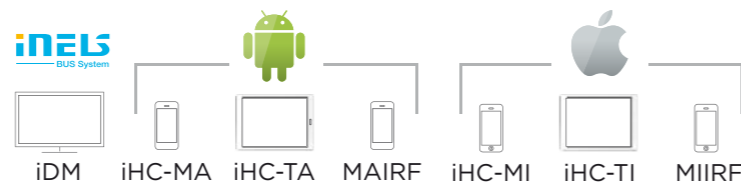

Device	iDM	iHC-MA	iHC-TA	MAIRF	iHC-MI	iHC-TI	MIIRF
Daikin RTD-NET	✗	✓	✓	✗	✗	✗	✗
LGPI-485	✓	✓	✓	✗	✗	✗	✗
Mitsubishi MELCOBEMS	✓	✓	✓	✗	✗	✗	✗
Coolmaster Net	✓	✓	✓	✗	✓	✓	✗
Daikin DK-AC-WMP-1	✗	✓	✓	✗	✗	✗	✗
LG LG-RC-WMP-1	✓	✓	✓	✗	✗	✗	✗
Samsung SM-ACN-MBS-4	✓	✓	✓	✗	✗	✗	✗
Midea MD-AC-MBS-1	✓	✓	✓	✗	✗	✗	✗
Intesis Box-WMP1 series	✓	✓	✓	✗	✗	✗	✗
eLAN-RS 485/232	✓	✓	✓	✓	✓	✓	✓
eLAN-IR-003	✓	✓	✓	✗	✓	✓	✗



Connection server

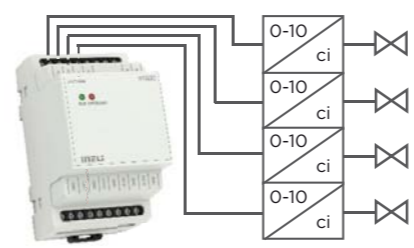
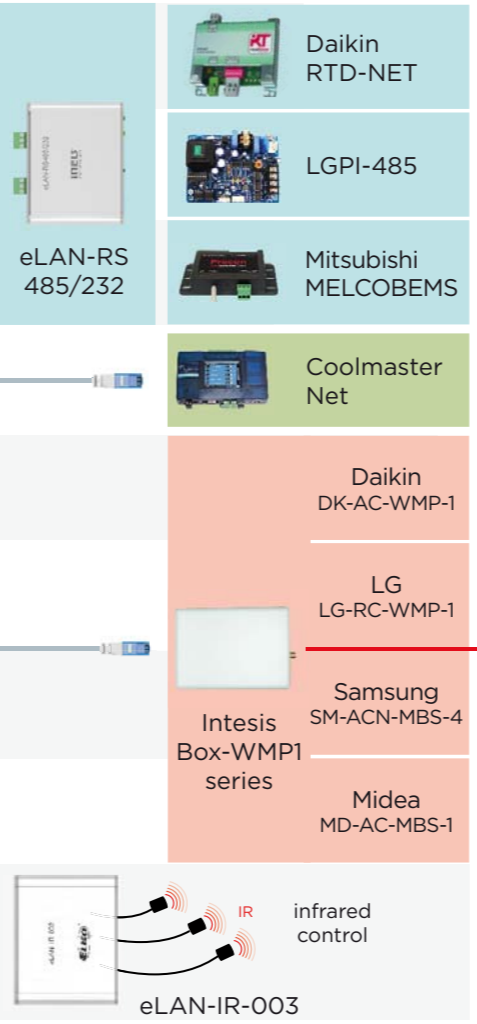

control via Digital/analog converter DAC3-04M

A/C brands



iDM v.3.3.34

The latest update of the iDM setup software brings support for new peripheral units, such as the 22-channel switching actuator SA3-022M and FAN-COIL of the FA3-612M, along with the implementation of new support functions. For example, the more effective filtering of results that allows you better orientation in more complex projects because it works by searching by unit name, note or hexadecimal address. Furthermore, the search for devices on bus, which has an impact on the efficiency of work with the project, where it is necessary to add an element without unnecessary scanning a clean project.

An interesting new feature is the support of proximity sensors in glass wall units, which allows the detection of a passing or approaching person and depending on the action set can, for example, turn on the backlight of the device or trigger various devices (in the form of a scene).

The work with functional blocks was also streamlined, where individual blocks can be shared between individual computers in the form of file import and export. A newly implemented important feature is the ability to move drives and virtual wires, which has a big impact on the time efficiency of programming (the programmer does not have to delete and re-establish connections between devices). In some cases, the order of the virtual wires may also matter, and it is now possible to change the wire positions in the overview by simply dragging the connection up or down.



Fan Coil Control Actuator FA3-612M



Switching actuator SA3-022M

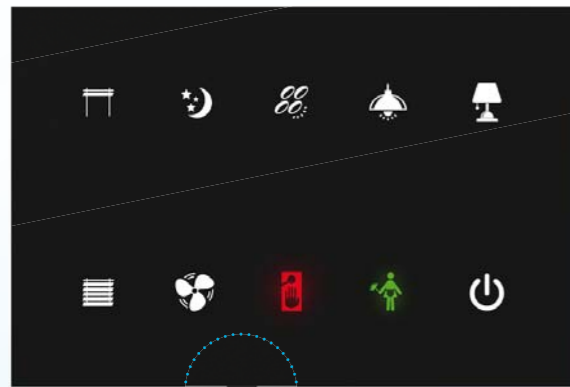

Proximity sensor

The iNELS BUS portfolio includes a new line of glass controls with proximity sensors. Irrespective of environmental conditions, it is able to detect a passing person or hand gestures. Among other things, the new series of units makes it possible to regulate the backlight level in several stages, which can be useful for controlling the unit at night (motion-controlled backlight does not disturb the occupants).

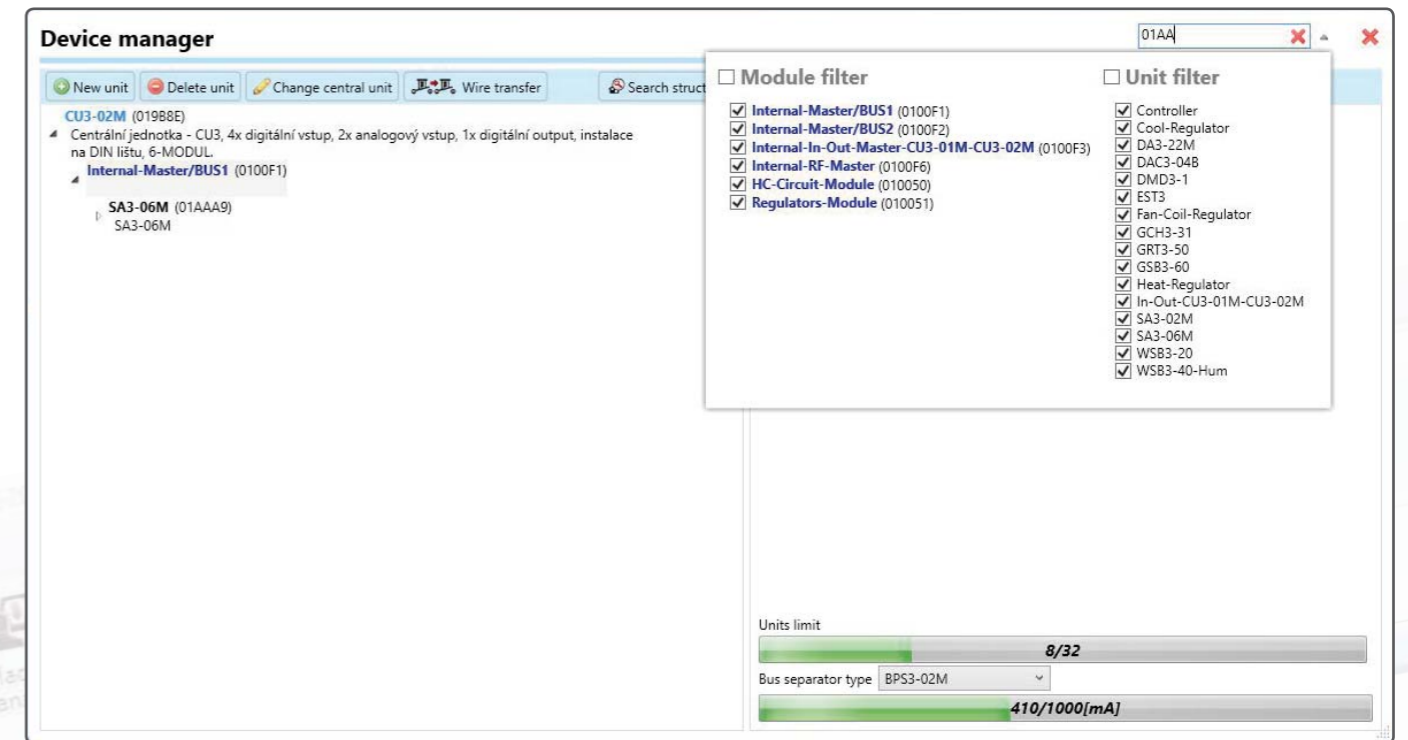

Search filter.

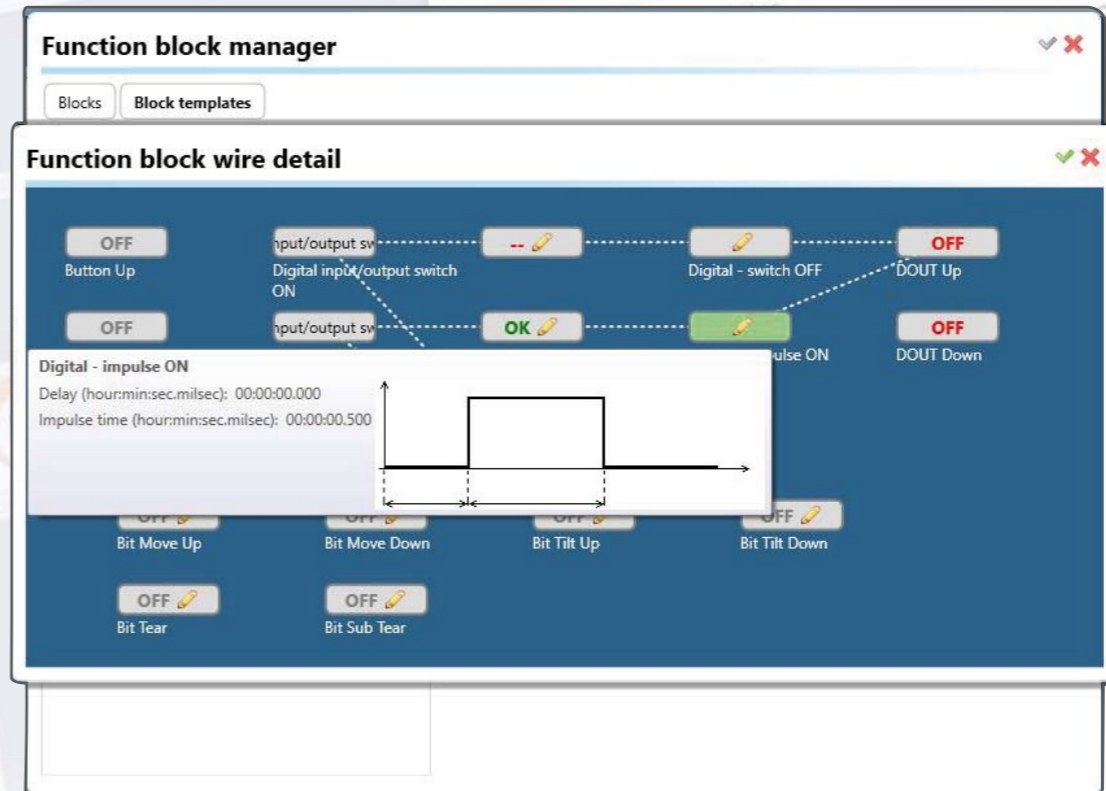

Function block detail.

Integration into superior software

Bridge

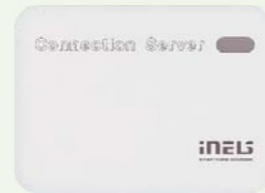
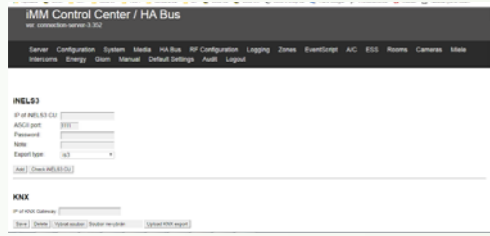

Connection Server

SCADA



Server

BMS - Building management system



JACE 9000



Flowbox Server



Wired (BUS)



Wireless (RF)



iNELS Air (IoT)



It is a solution built on this platform, allowing you to program or configure your installation using the SCADA tool. This includes creating a web-based monitoring environment based on object-oriented JavaScript. The interface created in the PROMOTIC environment allows constant access to all elements without having to stop the system during (re) configuration. The main advantages are:

- Programmable web interface and control logic in JavaScript or VBScript.
- Connectivity to various interfaces and repositories, such as XML, OPC, ActiveX, SQL.
- Possibility to use SVG vector graphics and edit it in the integrated graphics editor to visualize the interface.
- Alarm integration - alert the user to defined events with history logging.
- Possibility to organize graphically and tabular data in the form of so-called Trends.
- Surveillance can be extended by IP cameras via RTSP stream: <http://bit.ly/Webcam-en>.

The system uses the existing Ethernet infrastructure to communicate over TCP / IP protocol and in case

of different communication, the serial link (RS232 / RS485) is also used. All commands and feedback are processed by the main node in the infrastructure - server (Microsoft Windows workstation) with a component called Promotic runtime installed. This node communicates with terminal devices through software drivers that transmit data via API (iNELS RF) or ASCII (iNELS BUS).

A guidepost describing the communication interface between iNELS and Promotic can be found here: http://bit.ly/communication_iNELS.

The Promotic runtime component uses the Microsoft Windows environment, so any physical workstation can be used to run applications and services. This solution is also designed to run on a virtual machine (VirtualBox or Wmware). More information about licensing an application on a virtual machine can be found here: <http://bit.ly/virtual-en>. Operation of the software solution is, of course, a matter of license for a physical machine, where it is necessary to be aware of the number of controlled elements (so-called variables). Individual licenses for Promotic runtime can be found here: <http://bit.ly/licence-en>.

Various iNELS units can be connected to the Promotic environment due to the presence of software drivers. TCP / IP allows all requests to be transmitted over ASCII (CU3-0xM) or the JSON API (eLAN-RF-003).

A more detailed description of communication for iNELS BUS can be found here: <http://bit.ly/BUS-en>.

And iNELS RF here: http://bit.ly/Promotic_communications_RF.

IoT devices from the iNELS Air portfolio can also be indirectly integrated into the Promotic platform via the MQTT broker. More information can be found here: http://bit.ly/communication_loT-en.

All these different communication platforms can eventually be interconnected through a single web interface.

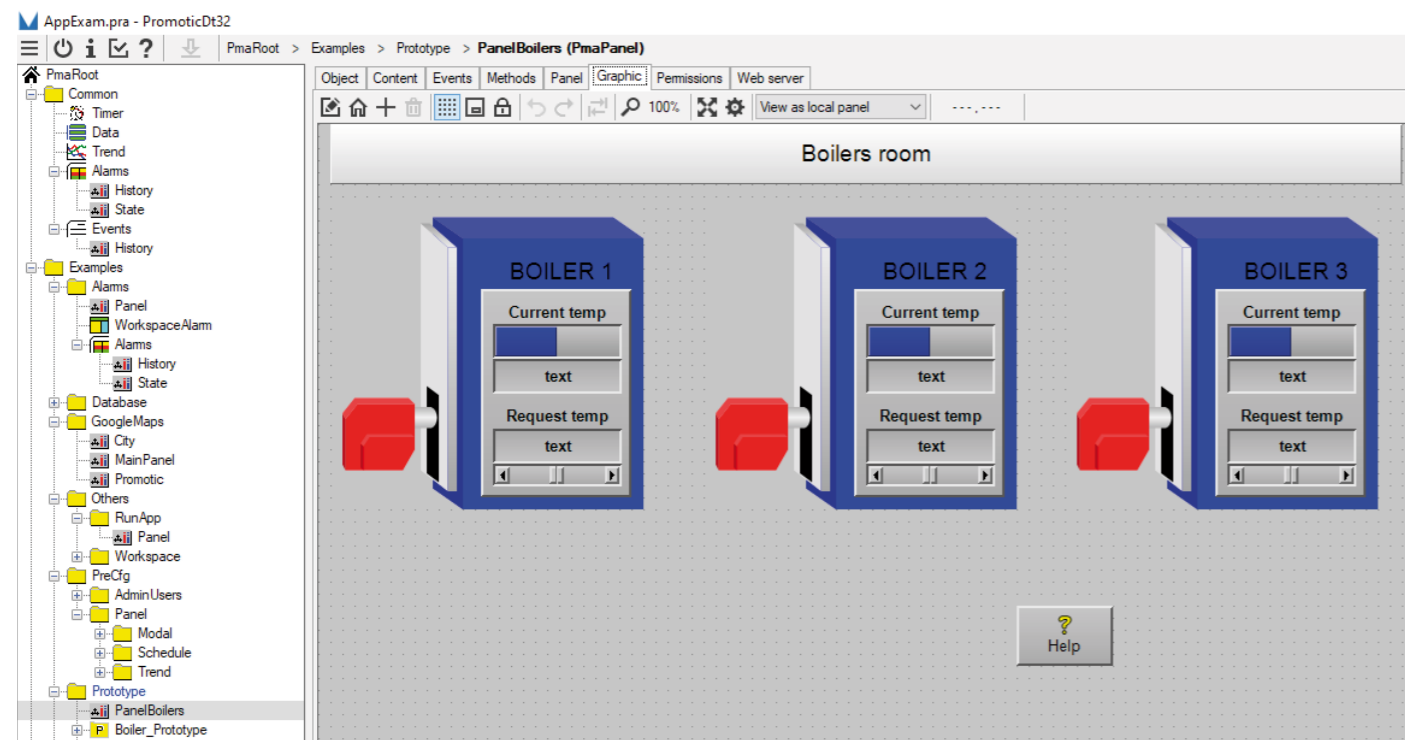

The user interface.



Programming interface.

iNELS reference

- PROMOTIC provides monitoring and regulation of room heating in the Abito Hotel in Prague. Rooms are located in 2 buildings: the hotel part and the hostel.
- Connection to the HORES hotel system allows real-time heating optimization according to occupancy or room reservation by hotel guests.
- The system reads data in real-time from iNELS controllers, processes them and monitors them. The system also enables manual changes (editing) of heating parameters.
- Thermoregulation RFATV-1 is used for the regulation itself.



Find out more about the solution:



Promotic
ELKO EP



Promotic
Official site



Promotic
Price list



Promotic
Terms and Conditions

ELKO EP: <https://www.elkoep.com/promotic-scada>
 Official site: <https://www.promotic.eu/en/pmdoc/WhatIsPromotic/WhatIsPromotic.htm>
 Price list: <https://www.promotic.eu/en/pmdoc/PriceList/PriceList.htm>
 Terms and Conditions: <https://www.promotic.eu/en/pmdoc/PriceList/PriceListConditions.htm>

Niagara Framework

It is a designation for software and hardware solutions developed by Tridium providing comprehensive control and supervision of home, commercial or industrial automation. The main advantages are:

- Programmable web interface / dashboards and JavaScript or HTML5 control logic for both desktop and phone. The user can also program by drag and drop.
- Connectivity to various interfaces and repositories, e.g. XML, OPC, ActiveX, MySQL, oBix.
- Ability to add custom software drivers written in Java for additional communication protocols.
- Integration of alarms and notifications - alerting the user to defined events with a link to history and communication means (telephone or e-mail server).
- Cooperation with Oracle hotel systems - API connectivity.
- Surveillance can be extended with IP cameras or entire DVRs.
- Support for diverse systems, including voice assistants.
- All software is OS independent - works reliably on both Microsoft Windows and Linux distributions.

The system uses the existing Ethernet infrastructure to communicate over TCP / IP protocol and in case a different communication method is required; the serial link (RS232 / RS485) is also used. All commands and feedback are processed by the main node in the infrastructure - a server (JACE 8000 physical controller or Microsoft Windows / Linux workstation) with Qnx operating system installed. This node communicates with terminal devices through the ASCII (iNELS BUS) driver.

The entire solution architecture is built on a virtual Java machine whose operating system is written to run either on Tridium hardware - JACE 8000: http://bit.ly/Niagara_JACE8000 - or on any workstation if Workbench software is installed carrying all important system components. The whole licensing model is based on the number of data points charged regardless of the communication protocol used.

Integrators use the tool called Workbench to create and edit projects, which allows you to create both network diagrams and graphical interfaces for the web or user dashboards. The software can handle drag and drop commands, but also serves as an interpreter for JavaScript or HTML5.

Only certified partners have access to all documentation related to software drivers and interface description. However, a list of available drivers can be found here: http://bit.ly/Niagara_ovladace-drivers.

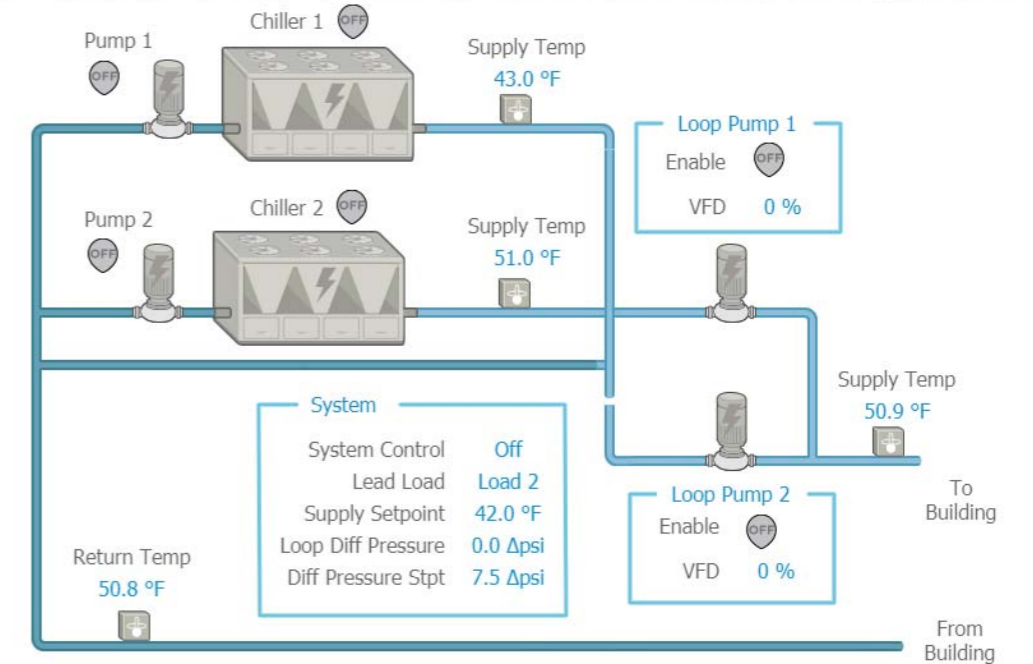
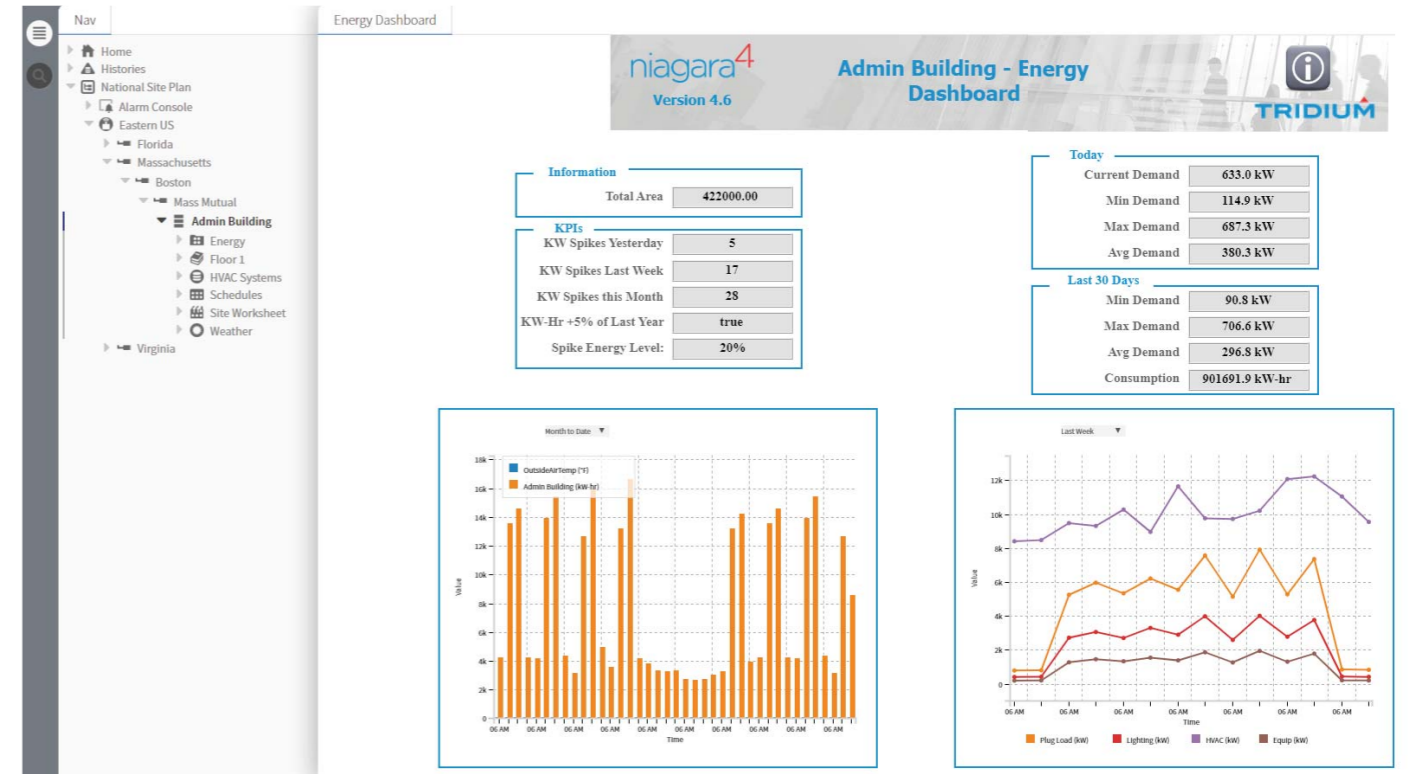

iNELS and Niagara Framework

Various iNELS controllers can be connected to the Niagara Framework through the presence of software drivers. TCP / IP allow all requests to be transmitted over ASCII (CU3-0xM) or indirectly via the JSON API (eLAN-RF-003). The framework also includes the presence of an MQTT driver to establish communication with devices from iNELS Air.

Our company is an exclusive distributor of Tridium hardware and software, including basic technical support for the combination of iNELS and Niagara Framework.

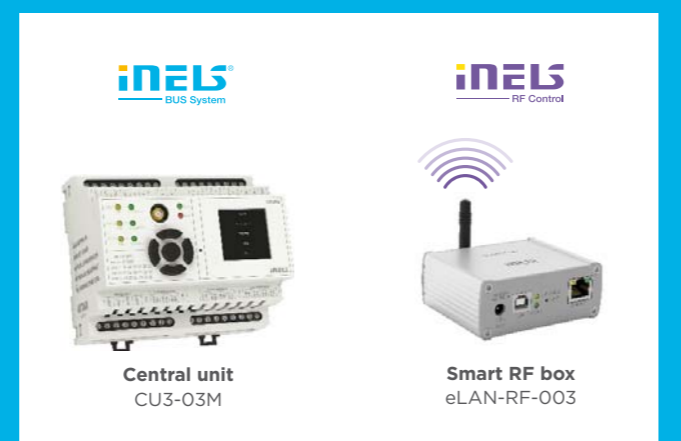

Find out more about the solution:



Niagara
ELKO EP



Niagara
Official site



Niagara
Products
and solutions

ELKO EP: <https://www.elkoep.com/inels-bms>
Official site: <https://www.tridium.com/en/products-services/niagara4>
Products and solutions: <https://www.tridium.com/en/resources/library>

FLOWBOX



The philosophy of the FlowBox system is to integrate monitoring and control of all systems into one centre, which is able to integrate gas boilers, infrared heaters, heat recovery units, fans, destratifiers, radiators, infrared heaters, electrically controlled skylights, adjustable LED lighting, camera systems, security and more. The whole system can be used in three ways: as a dedicated cloud for closed objects, an intranet solution for large installations, or a public IoT cloud. The platform is based on MASTER => SLAVE, but also MASTER => subMASTER or Gateway or subMASTER => SLAVE.

The architecture of the system is based on so-called realms (platform environment) aggregating all monitored or controllable elements.

Access to the system is via mainly modern web browsers supporting HTML5, jQuery and JS Stack, which can work with a responsive design.

The system manages to aggregate and distribute data via MONGO or SQL databases, while platform control is based on the multi-paradigmatic RUST language.

There are a number of tools for connecting with third parties via the API using eg HTTPS (which is the case for REST API, ASCII), Modbus (TCP / RTU), DALI, M-BUS, MQTT and others - the system is then truly cross-platform.

Programming in the FLOWBOX interface is done using a simple C or PHP-like syntax.

This platform is easy to deploy with clear hardware and software requirements. The system must use Linux or Debian OS running on an Intel CPU and can also be run as a virtual machine.

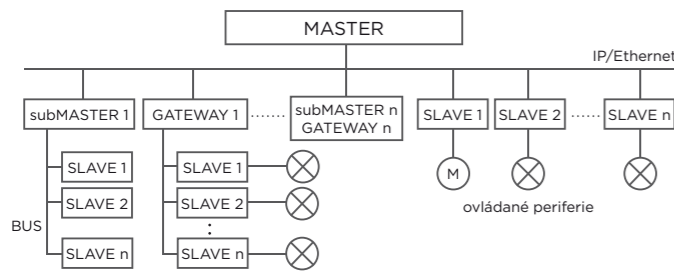

iNELS and Flowbox

Software implementation between Flowbox and iNELS will be completed soon. Interconnection in the form of a software driver will enable customers to safely control and monitor our devices via API (JSON), ASCII or MQTT broker.



Wall switch button
WSB3-40



Universal dimming actuator
DA3-22M

Find out more about the solution:



Flowbox
Official site



Flowbox
Compare
of products

Official site: <http://www.flowbox.com/en>
Compare of products: <http://www.flowbox.com/en/products-compare>

The price list of products and services is not published, but Flowbox prefers to consult each design to create the most efficient and affordable solution.

Overview table

A solution based on BMS can be covered by four following options. The main difference is amount of available features related to control and supervision.

Feature	iNELS iDM	PROVOTIC	powered by niagara framework	FLOWBOX
programming interface	✓	✓	✓	✓
virtual wire amount limitation	✓	✗	✗	✗
integration of mathematical or logical functions	✓*	✓	✓	✓
third-party interconnection (ASCII or software drivers)	✓**	✓	✓	✓
alarm / calls / text / e-mail notifications	✓***	✓	✓	✓
support of ORACLE hospitality solution (Fidelio / Opera)	✗	✓	✗	✗
support of multiple CU3-OxM	✗	✓	✓	✓
SCADA interface/support	✗	✓	✓	✓
iNELS RF interconnection (RFIO or JSON)	✓	✓	✓	✓
iNELS Air interconnection (MQTT)	✗	✓	✓	✓
HTML5 / JavaScript frontend - dashboards and web supervisor	✗	✓	✓	✓
multimedia integration (CCTV, audio, video)	✗	✓	✓****	✗
History logging	✓	✓	✓	✓
SQL interconnection	✗	✓	✓	✓

* basic features implemented only
 ** partial support: via ASCII or selected drivers only
 *** partial support: calls and texts only
 **** partial support: CCTV only

iNELS BUS for iRidium Mobile

The customizable interface area is represented by an iRidium Mobile solution that offers customized GUIs for mobile platforms (independent of the operating system) and allows the integration of different protocols using various software drivers.

iRidium software solution enables controlling of the iNELS home automation system as well as other 3rd parties devices (audio/video devices, media servers with full two way communication). iRidium offers a set of tools, scripts and customizable interfaces which enables the end user to create their own unique face of the application which is able to send and receive variable status data via EPSNET proto-

col. It is possible to control and monitor the status of individual luminaires, blinds, heating, etc. on devices such as iPad, iPhone, Mac, Android or Windows.

Your end customer gets a complete solution for controlling all devices in one application.

Commands & Feedbacks

Commands and feedback channels have to be assigned to graphic items to control equipment:

- A command is assigned to a graphic item.
- Feedback channel is assigned to a graphic item to display the variable state.

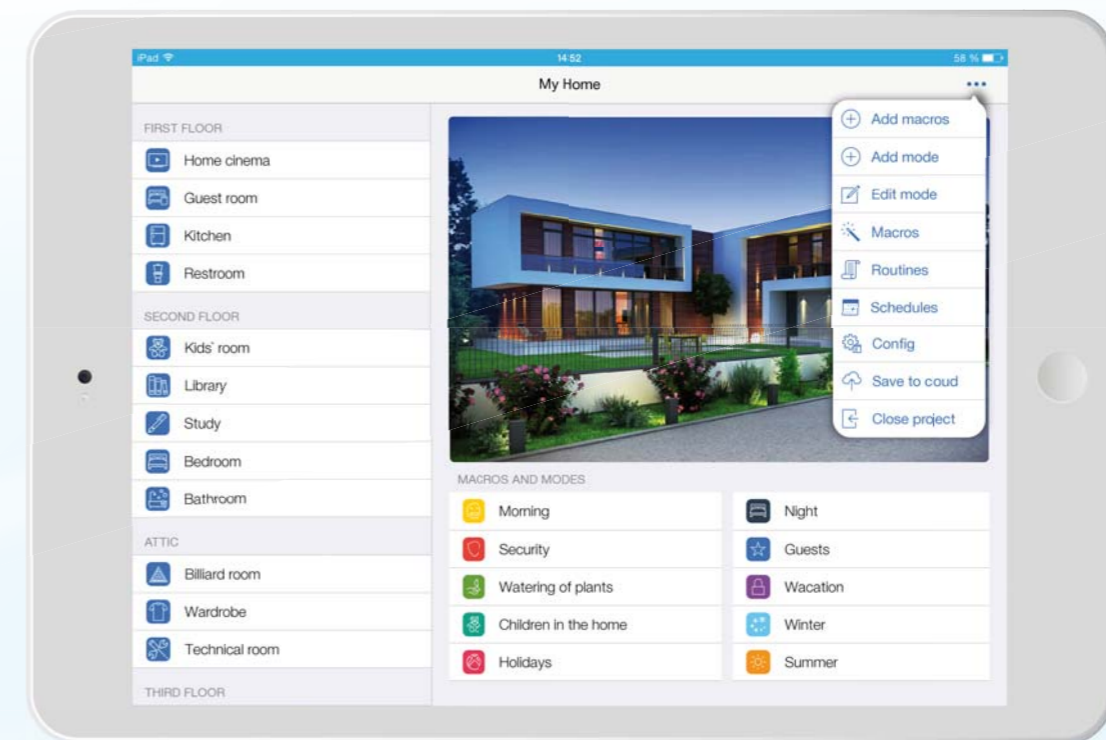

Find out more about the solution:



iRidium
Official site



iRidium
E-courses



iRidium
iNELS driver



Watch the VIDEO:

Official site: <https://iridi.com/>
 E-courses: <https://iridi.com/academy/>
 iNELS driver: <https://dev.iridi.com/ElkoEp/en>

Demonstrating the possibilities of iNELS RF Control



Homester is packed with a state-of-the-art intelligent system where you can control all the features at a distance, from the comfort of the caravan seat, or from outside, just by using your smart phone and unique A1 Application. The application communicates through a special RF-WiFi SmartBox installed in the vehicle that receives the wifi command from your handy (PDA, tablet), converts the signal to a radio command, and through a special actuator turns on, or disables any selected function.

Using A1 App, you can unlock camper, tilt and close the entrance door with integrated stairs, control the lights throughout the vehicle, lift or lower the top floor, push or slide the washbasin with the table on the top floor, open the kitchen wall with extra desk-top, or level your motorhome position using four Independently controlled stabilizing leg-supports. Other additional systems such as heating, air conditioning, power stations or various multimedia devices can be controlled by the application as well.

A1 App will monitor your wifi cameras, so you can watch the events around your camper on the screen of your mobile, tablet, or TV, as well as the interior of

the top floor, during the roof launch, or even parking maneuvering. The application checks and informs your weather prediction, the indoor and outdoor sensors are sending the actual temperature data several times per minute, various warning sensors monitors the gas leakage, water, or violent disturbance of the vehicle from outside. The A1 SmartBox is synchronized with the satellite wifi router (no local SIM card is needed), which provides a worldwide internet connection for the whole crew.

In case you do not use a smart phone, PDA, tablet, etc. or you own an older model without a touch screen, the A1 App provides the Pilot remote control with a color display. If you do not even have a mobile phone, and your Pilot remote control is lost or unavailable, every actuator controlling each device in camper can be equipped with a separate wireless wall switch, that sticks wherever you want and can be used as a classic mechanical switch. Whatever the number of switches and their features are used, the A1 App still provides you with a status check on the display whether it is OFF or ON and its simultaneous remote controlling.



Find out more about the solution:



A1 ATTACK
Official site

Official site: <http://www.a1attack.com/homester/index-en.html>

Come to see our innovations

ELEC EXPO 2019

Date: October 30 to November 02, 2019

Place: Casablanca, Morocco

The 13th edition of ELEC expo Electricity, Lighting, Electrical Engineering and Industrial Automation. ELEC EXPO is the largest electrical and energy exhibition in Morocco. ELKO EP will be one of the few Czech companies in Morocco to present its range of modular electronic devices and smart solutions, which we offer under our own brand iNELS.



VSK 2020

Date: February 04 to 07, 2020

Place: Utrecht, Nederland

Better, smarter, energy-efficient houses, buildings and industrial environments. This requires the know-how of professional installers. And they visit VSK. And since ELKO EP is one of the world leaders in the field of Building Management System (BMS), which includes comprehensive lighting, heating and energy management systems, we cannot miss this fair.



LIGHT + BUILDING

Date: March 08 to 13 2020

Place: Frankfurt am Main, Germany

The world's leading trade fair for lighting and building services technology. Frankfurt am Main is the place where premieres are celebrated and trends are set. Experts can look forward to a wide range of ELKO EP components for bus and wireless electrical installations, IoT solutions for smart cities or agriculture, a comprehensive solution for existing and newly built hotels, or constantly improving software applications.

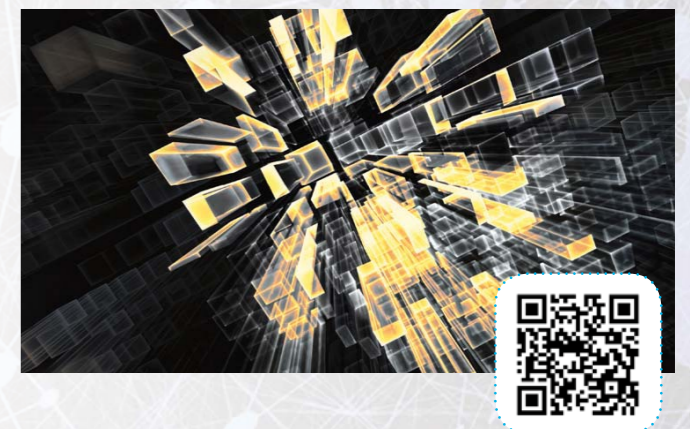

New references



Marriott Marquis
Doha, Qatar

- 5-star hotel in the Doha City center
- lighting control, HVAC control,
- master switch OFF
- 44 floors, 397 rooms, 182 suites, 18 meeting rooms



Hotel Isla Mallorca & Spa
Mallorca, Spain

- 4-star hotel in Palma de Mallorca
- 10 floors, 154 rooms, wellness, bars, restaurant, meeting rooms
- lighting control, HVAC control
- exit button (switch OFF)



Rocks Hotel & Casino
Kyrenia, Cyprus

- 5-star hotel
- located close to historical city Kyrenia
- the lights are controlled by iNELS system via light panel, USB socket, glass thermostats



Residence Riverside Limassol
Germasogeia, Cyprus

- luxury residence uses iNELS Smart Home System
- built according to the AAA standard
- Smart Energy Management System



Chauhanji's Residence
India

- used iNELS RF Control
- controlling the lighting by RFWB-40 wireless switches and the RFSA-61B multifunction switch units
- iNELS Home Control mobile app



Bhutan National Bank
Timphu, Bhutan

- fully equipped with iNELS bus and RF installations
- more than 300 iNELS elements & 2,000 lights under the full control of the iNELS Bus System
- 10" Touch Panels with iNELS Home Control app on each floor



Radisson Ridzen Hotel
Riga, Latvia

- 7 lighting zones integrated in iNELS RF system
- sockets near beds for comfortable staying
- switches with laser-printed icons



Arigone Hotel
Olomouc, Czech Republic

- intelligent installation iNELS
- Guest Room Management System with CU3-04M Hotel Bundle
- ready for communication with iNELS BMS



Family house
Gabrovo, Bulgaria

- fully equipped with iNELS Smart Home Control
- lighting, blinds, heating and ventilation control
- automatic garden lighting, irrigation, gutter and driveway defrosting



Buddha Palace
Thimphu, Bhutan

- lighting control of historical interior sections
- scenes light according to visitor presence
- security system



Museum Hermitage
St. Petersburg, Russia

- one of the world's most famous museums, based in St. Petersburg
- dimming of selected zones with DIM-6
- cooperating with wireless RFDAC-71B controller



Magyar State Opera
Budapest, Hungary

- every additional lighting source is controlled by iNELS system
- the devices here are controlled by RF Touch
- for switching the RFSA-11B and RFSA-66M is used

Facts and stats

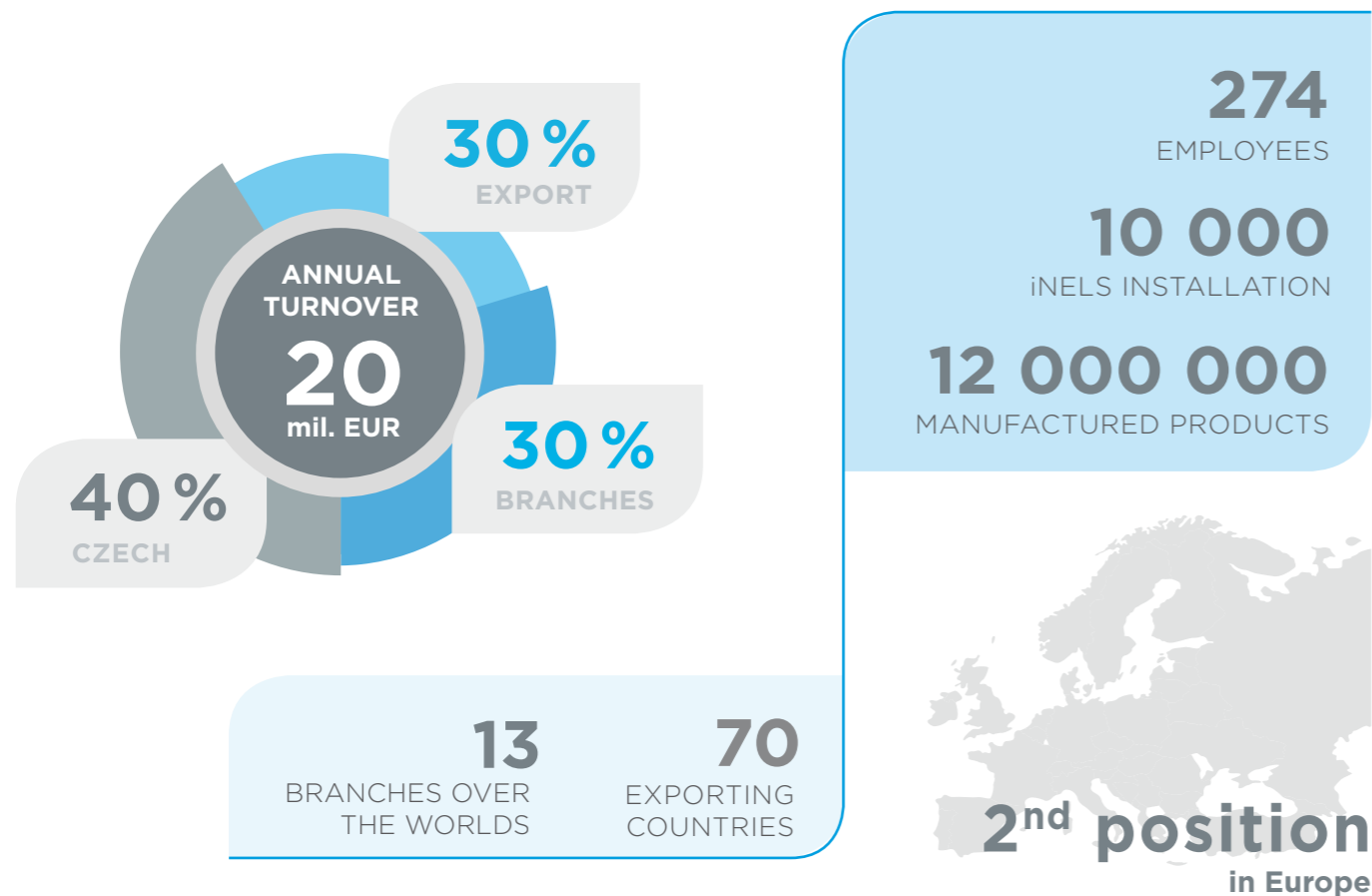

WE ARE

DEVELOPERS

In the new R&D center, more than 30 engineers develop new products and extend the functionality of existing products

PRODUCERS

modern antistatic spaces, 2x fully automated SMD production lines, 2 shift operations.

SUPPORT

24 hours / 7 days / 360 days we not only provide technical support but also logistics.

SELLERS

personal access to more than 70 sales representatives in ELKO EP Holding provides impeccable services and superior products at an affordable price.

Others just resell

HOWEVER, WE DEVELOP AND MANUFACTURE PRODUCTS OURSELVES!

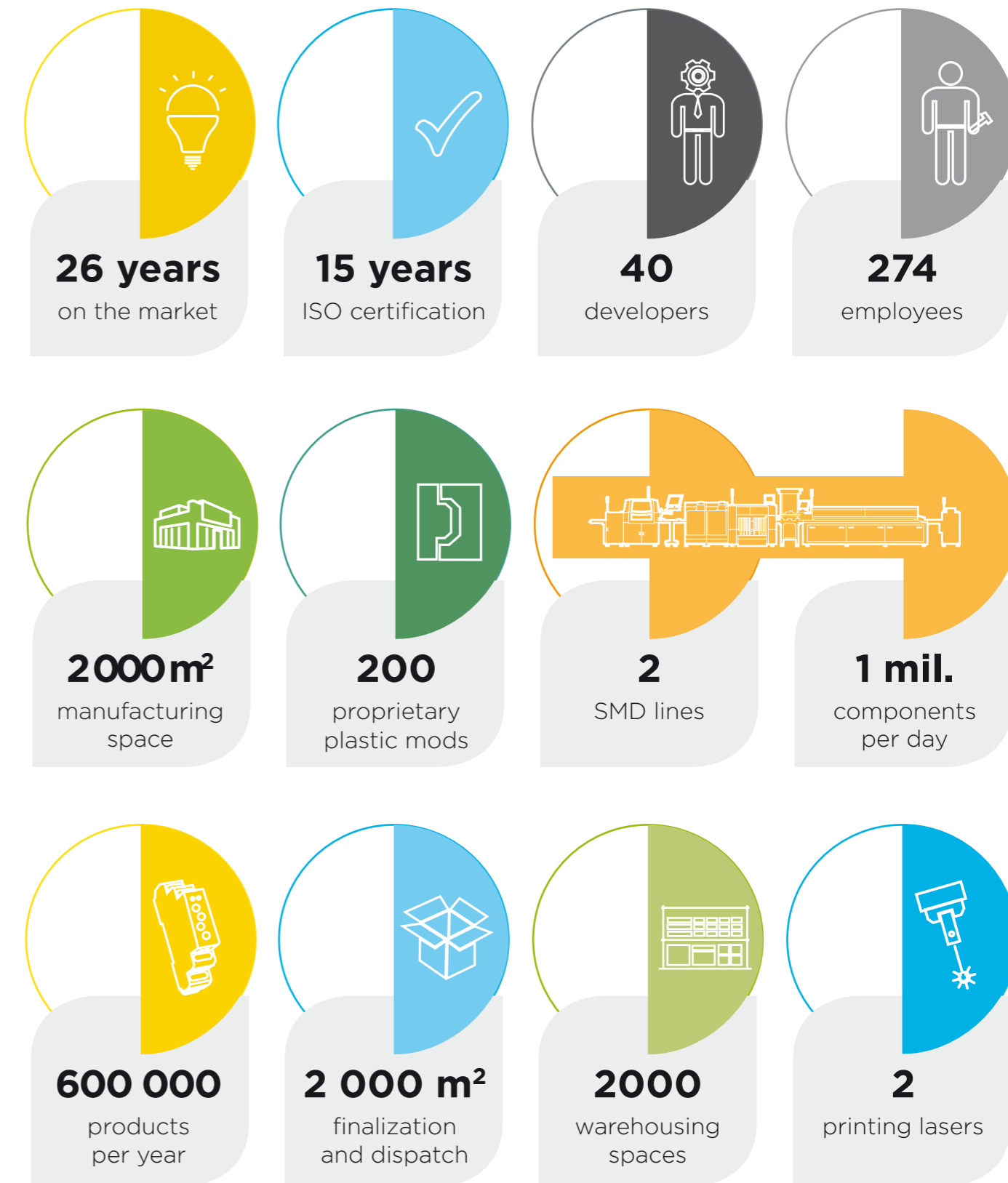

ELKO EP Holding



phone
+420 800 100 671



e-mail
export@elkoep.com



www.elkoep.com
www.inels.com